

Vantage 500 DEUTZ

For use with machines having Code Numbers: **10995**

Safety Depends on You

Lincoln arc welding and cutting equipment is designed and built with safety in mind. However, your overall safety can be increased by proper installation . . . and thoughtful operation on your part. **DO NOT INSTALL, OPERATE OR REPAIR THIS EQUIPMENT WITHOUT READING THIS MANUAL AND THE SAFETY PRECAUTIONS CONTAINED THROUGHOUT.** Most importantly, think before you act and be careful.



OPERATOR'S MANUAL



Copyright© 2004 Lincoln Global Inc.

• World's Leader in Welding and Cutting Products •
• Sales and Service through Subsidiaries and Distributors Worldwide •
Cleveland, Ohio 44117-1199 USA Tel: 216.481.8100 Fax: 216.486.1751 Web Site: www.lincolnelectric.com

**WARNING****CALIFORNIA PROPOSITION 65 WARNINGS**

For Diesel Engines: diesel engine exhaust and some of its constituents are known to the State of California to cause cancer, birth defects, and other reproductive harm.

For Gasoline Engines: The engine exhaust from this product contains chemicals known to the State of California to cause cancer, birth defects, or other reproductive harm.

ARC WELDING CAN BE HAZARDOUS. PROTECT YOURSELF AND OTHERS FROM POSSIBLE SERIOUS INJURY OR DEATH. KEEP CHILDREN AWAY. PACEMAKER WEARERS SHOULD CONSULT WITH THEIR DOCTOR BEFORE OPERATING.

Read and understand the following safety highlights. For additional safety information, it is strongly recommended that you purchase a copy of "Safety in Welding & Cutting - ANSI Standard Z49.1" from the American Welding Society, PO Box 351040, Miami, Florida 33135 or CSA Standard W117.2-1974 or WTIA (Welding Technology Institute of Australia), PO Box 6165, Silverwater, NSW, 2128. A free copy of "Arc Welding Safety" booklet E205 is available from the Lincoln Electrical Company, 22801 St Clair Avenue, Cleveland, Ohio 44117-1199.

BE SURE THAT ALL INSTALLATION, OPERATION, MAINTENANCE AND REPAIR PROCEDURES ARE PERFORMED ONLY BY QUALIFIED INDIVIDUALS.

**FOR ENGINE powered equipment.**

1.a Turn the engine off before troubleshooting and maintenance work unless the maintenance work requires it to be running.



1.b. Operate engines in open, well ventilated areas or vent the engine exhaust fumes outdoors.



1.c. Do not add fuel near an open flame, welding arc or when the engine is running. Stop the engine and allow it to cool before refuelling to prevent spilled fuel from vaporizing on contact with hot engine parts and igniting. Do not spill fuel when filling tank. If fuel is spilled, wipe it up and do not start engine until fumes have been eliminated.

1.d. Keep all equipment, safety guards, covers and devices in position and in good repair. Keep hands, hair, clothing and tools away from V-belts, gears, fans and all other moving parts when starting, operating or repairing equipment.

1.e. In some cases it may be necessary to remove safety guards to perform required maintenance. Remove guards only when necessary and replace them when the maintenance requiring their removal is complete. Always use the greatest care when working near moving parts.



1.f. Do not put your hands near the engine fan. Do not attempt to override the governor or idler by pushing on the throttle control rods while the engine is running.

1.g. To prevent accidentally starting petrol engines while turning the engine or welding generator during maintenance work, disconnect the spark plug wires, distributor cap or magneto wire as appropriate.



1.h. To avoid scalding, do not remove the radiator pressure cap when the engine is hot.

**ELECTRIC AND MAGNETIC FIELDS may be dangerous**

2.a. Electric current flowing through any conductor causes localized Electric and Magnetic Fields (EMF). Welding current creates EMF fields around welding cables and welding machines.

2.b. EMF fields may interfere with some pacemakers and welders having a pacemaker should consult their physician before welding.

2.c. Exposure to EMF fields in welding may have other health effects which are now not known.

2.d. All welders should use the following procedures in order to minimize exposure to EMF fields from the welding circuit:

2.d.1. Route the electrode and work cables together. Secure them with tape when possible.

2.d.2. Never coil the electrode lead around your body.

2.d.3. Do not place your body between the electrode and work cables. If the electrode cable is on your right side, the work cable should also be on your right side.

2.d.4. Connect the work cable to the workplace as close as possible to the area being welded.

2.d.5. Do not work next to welding power source.

Mar '95



ELECTRIC SHOCK can kill.

- 3.a. The electrode and work (or ground) circuits are electrically "hot" when the welder is on. Do not touch these "hot" parts with your bare skin or wet clothing. Wear dry, hole-free gloves to insulate hands.
- 3.b. Insulate yourself from work and ground using dry insulation. Make certain the insulation is large enough to cover your full area of physical contact with work and ground.
- In addition to the normal safety precautions, if welding must be performed under electrically hazardous conditions (in damp locations or while wearing wet clothing; on metal structures such as floors, gratings or scaffolds; when in cramped positions such as sitting, kneeling or lying, if there is a high risk of unavoidable or accidental contact with the workpiece or ground) use the following equipment:**
- **Semiautomatic DC Constant Voltage (Wire) Welder.**
 - **DC Manual (Stick) Welder.**
 - **AC Welder with Reduced Voltage Control.**
- 3.c. In semi-automatic or automatic wire welding, the electrode, electrode reel, welding head, nozzle or semi-automatic welding gun are also electrically "hot".
- 3.d. Always be sure the work cable makes a good electrical connection with the metal being welded. The connection should be as close as possible to the area being welded.
- 3.e. Ground the work or metal to be welded to a good electrical (earth) ground.
- 3.f. Maintain the electrode holder, work clamp, welding cable and welding machine in good, safe operating condition. Replace damaged insulation.
- 3.g. Never dip the electrode holder in water for cooling.
- 3.h. Never simultaneously touch electrically "hot" parts of electrode holders connected to two welders because voltage between the two can be the total of the open circuit voltage of both welders.
- 3.i. When working above floor level, use a safety belt to protect yourself from a fall should you get a shock.
- 3.j. Also see items 6c and 8.



ARC RAYS can burn.

- 4.a. Use a shield with the proper filter and cover plates to protect your eyes from sparks and the rays of the arc when welding or observing open arc welding. Headshield and filter lens should conform to ANSI Z87.1 standards.
- 4.b. Use suitable clothing made from durable flame resistant material to protect your skin and that of your helpers from the arc rays.
- 4.c. Protect other nearby personnel with suitable non flammable screening and/or warn them not to watch the arc or expose themselves to the arc rays or to hot spatter or metal.



FUMES AND GASES can be dangerous

- 5.a. Welding may produce fumes and gases hazardous to health. Avoid breathing these fumes and gases. When welding, keep your head out of the fume. Use enough ventilation and/or exhaust at the arc to keep fumes and gases away from the breathing zone. **When welding with electrodes which require special ventilation such as stainless or hard facing (see instructions on container or MSDS) or on lead or cadmium plated steel and other metals or coatings which produce highly toxic fumes, keep exposure as low as possible and below Threshold Limit values (TLV) using local exhaust or mechanical ventilation. In confined spaces or in some circumstances, outdoors, a respirator may be required. Additional precautions are also required when welding on galvanized steel.**
- 5.b. Do not weld in locations near chlorinated hydrocarbon vapors coming from degreasing, cleaning or spraying operations. The heat and rays of the arc can react with solvent vapors to form phosgene, a highly toxic gas, and other irritating products.
- 5.c. Shielding gases used for arc welding can displace air and cause injury or death. Always use enough ventilation, especially in confined areas, to ensure breathing air is safe.
- 5.d. Read and understand the manufacturer's instructions for this equipment and the consumables to be used, including the material safety data sheet (MSDS) and follow your employer's safety practices. MSDS forms are available from your welding distributor or from the manufacturer.
- 5.e. Also see Item 1b.

Mar '95



WELDING SPARKS can cause fire or explosion

- 6 a Remove fire hazards from the welding area. If this is not possible, cover them to prevent the welding sparks from starting a fire. Remember that welding sparks and hot materials from welding can easily go through small cracks and openings to adjacent areas. Avoid welding near hydraulic lines. Have a fire extinguisher readily available.
- 6.b. Where compressed gases are to be used at the job site, special precautions should be used to prevent hazardous situations. Refer to AS1674 Parts 1 & 2 "Safety in Welding and Cutting" (ANSI Standard Z49.1) and the operating information for the equipment being used.
- 6.c. When not welding, make certain no part of the electrode circuit is touching the work or ground. Accidental contact can cause overheating and create a fire hazard.
- 6.d. Do not heat, cut or weld tanks, drums or containers until the proper steps have been taken to insure that such procedures will not cause flammable or toxic vapors from substances inside. These can cause an explosion even though the vessel has been "cleaned". For information purchase "Recommended Safe Practices for the Preparation for Welding and Cutting of Containers and Piping that have held Hazardous Substances", AWS F4.1 from the American Welding Society (see address above).
- 6.e. Vent hollow castings or containers before heating, cutting or welding. They may explode.
- 6.f. Sparks and spatter are thrown from the welding arc. Wear oil free protective garments such as leather gloves, heavy shirt, cuffless trousers, high shoes and a cap over your hair. Wear ear plugs when welding out of position or in confined places. Always wear safety glasses with side shields when in a welding area.
- 6.g. Connect the work cable to the work as close to the welding area as possible. Work cables connected to the building framework or other locations away from the welding area increase the possibility of the welding current passing through lifting chains, crane cables or other alternate circuits. This can create fire hazards or overheat lifting chains or cables until they fail.
- 6.h. Also see Item 1c.



CYLINDER may explode if damaged

- 7.a. Use only compressed gas cylinders containing the correct shielding gas for the process used and properly operating regulators, designed for the gas and pressure used. All hoses, fittings, etc. should be suitable for the application and maintained in good condition.
- 7.b. Always keep cylinders in an upright position and securely chained to an undercarriage or fixed support.
- 7.c. Cylinders should be located :
- Away from areas where they may be struck or subjected to physical damage.
 - A safe distance from arc welding or cutting operations and any other source of heat, sparks or flame.
- 7.d. Never allow the electrode, electrode holder, or any other electrically "hot" parts to touch a cylinder.
- 7.e. Keep your head and face away from the cylinder valve outlet when opening the cylinder valve.
- 7.f. Valve protection caps should always be in place and hand-tight except when the cylinder is in use or connected for use.
- 7.g. Read and follow the instructions on compressed gas cylinders, associated equipment, and CGA publication P-1, "Precautions for Safe Handling of Compressed Gases in Cylinders", available from the Compressed Gas Association 1235 Jefferson Davis Highway, Arlington, VA 22202.



FOR ELECTRICALLY powered equipment.

- 8.a. Turn off input power using the disconnect switch at the fuse box before working on the equipment.
- 8.b. Install equipment in accordance with the National Electrical Code, all local codes and the manufacturer's recommendations.
- 8.c. Ground the equipment in accordance with the National Electrical Code and the manufacturer's recommendations.

Mar '95

PRÉCAUTIONS DE SÛRETÉ

Pour votre propre protection lire et observer toutes les instructions et les précautions de sûreté spécifiques qui paraissent dans ce manuel aussi bien que les précautions de sûreté générales suivantes:

Sûreté Pour Soudage A L'Arc

1. Protégez-vous contre la secousse électrique:
 - a. Les circuits à l'électrode et à la pièce sont sous tension quand la machine à souder est en marche. Eviter toujours tout contact entre les parties sous tension et la peau nue ou les vêtements mouillés. Porter des gants secs et sans trous pour isoler les mains.
 - b. Faire très attention de bien s'isoler de la masse quand on soude dans des endroits humides, ou sur un plancher métallique ou des grilles métalliques, principalement dans les positions assis ou couché pour lesquelles une grande partie du corps peut être en contact avec la masse.
 - c. Maintenir le porte-électrode, la pince de masse, le câble de soudage et la machine à souder en bon et sûr état de fonctionnement.
 - d. Ne jamais plonger le porte-électrode dans l'eau pour le refroidir.
 - e. Ne jamais toucher simultanément les parties sous tension des porte-électrodes connectés à deux machines à souder parce que la tension entre les deux pinces peut être le total de la tension à vide des deux machines.
 - f. Si on utilise la machine à souder comme une source de courant pour soudage semi-automatique, ces précautions pour le porte-électrode s'appliquent aussi au pistolet de soudage.
2. Dans le cas de travail au dessus du niveau du sol, se protéger contre les chutes dans le cas où on recoit un choc. Ne jamais enrouler le câble-électrode autour de n'importe quelle partie du corps.
3. Un coup d'arc peut être plus sévère qu'un coup de soliel, donc:
 - a. Utiliser un bon masque avec un verre filtrant approprié ainsi qu'un verre blanc afin de se protéger les yeux du rayonnement de l'arc et des projections quand on soude ou quand on regarde l'arc.
 - b. Porter des vêtements convenables afin de protéger la peau de soudeur et des aides contre le rayonnement de l'arc.
 - c. Protéger l'autre personnel travaillant à proximité au soudage à l'aide d'écrans appropriés et non-inflammables.
4. Des gouttes de laitier en fusion sont émises de l'arc de soudage. Se protéger avec des vêtements de protection libres de l'huile, tels que les gants en cuir, chemise épaisse, pantalons sans revers, et chaussures montantes.
5. Toujours porter des lunettes de sécurité dans la zone de soudage. Utiliser des lunettes avec écrans latéraux dans les zones où l'on pique le laitier.

6. Eloigner les matériaux inflammables ou les recouvrir afin de prévenir tout risque d'incendie dû aux étincelles.
7. Quand on ne soude pas, poser la pince à une endroit isolé de la masse. Un court-circuit accidentel peut provoquer un échauffement et un risque d'incendie.
8. S'assurer que la masse est connectée le plus près possible de la zone de travail qu'il est pratique de le faire. Si on place la masse sur la charpente de la construction ou d'autres endroits éloignés de la zone de travail, on augmente le risque de voir passer le courant de soudage par les chaînes de levage, câbles de grue, ou autres circuits. Cela peut provoquer des risques d'incendie ou d'échauffement des chaînes et des câbles jusqu'à ce qu'ils se rompent.
9. Assurer une ventilation suffisante dans la zone de soudage. Ceci est particulièrement important pour le soudage de tôles galvanisées plombées, ou cadmiées ou tout autre métal qui produit des fumeés toxiques.
10. Ne pas souder en présence de vapeurs de chlore provenant d'opérations de dégraissage, nettoyage ou pistolage. La chaleur ou les rayons de l'arc peuvent réagir avec les vapeurs du solvant pour produire du phosgène (gas fortement toxique) ou autres produits irritants.
11. Pour obtenir de plus amples renseignements sur la sûreté, voir le code "Code for safety in welding and cutting" CSA Standard W 117.2-1974.

PRÉCAUTIONS DE SÛRETÉ POUR LES MACHINES À SOUDER À TRANSFORMATEUR ET À REDRESSEUR

1. Relier à la terre le chassis du poste conformément au code de l'électricité et aux recommandations du fabricant. Le dispositif de montage ou la pièce à souder doit être branché à une bonne mise à la terre.
2. Autant que possible, l'installation et l'entretien du poste seront effectués par un électricien qualifié.
3. Avant de faire des travaux à l'intérieur de poste, la débrancher à l'interrupteur à la boîte de fusibles.
4. Garder tous les couvercles et dispositifs de sûreté à leur place.

Mar. '93

Thank You

for selecting a **QUALITY** product by Lincoln Electric. We want you to take pride in operating this Lincoln Electric Company product ••• as much pride as we have in bringing this product to you!

Please Examine Carton and Equipment For Damage Immediately

When this equipment is shipped, title passes to the purchaser upon receipt by the carrier. Consequently, Claims for material damaged in shipment must be made by the purchaser against the transportation company at the time the shipment is received.

Please record your equipment identification information below for future reference. This information can be found on your machine nameplate.

Product _____

Model Number _____

Code Number or Date Code _____

Serial Number _____

Date Purchased _____

Where Purchased _____

Whenever you request replacement parts or information on this equipment, always supply the information you have recorded above. The code number is especially important when identifying the correct replacement parts.

On-Line Product Registration

- Register your machine with Lincoln Electric either via fax or over the Internet.

- For faxing: Complete the form on the back of the warranty statement included in the literature packet accompanying this machine and fax the form per the instructions printed on it.
- For On-Line Registration: Go to our **WEB SITE at www.lincolnelectric.com**. Choose "Quick Links" and then "Product Registration". Please complete the form and submit your registration.

Read this Operators Manual completely before attempting to use this equipment. Save this manual and keep it handy for quick reference. Pay particular attention to the safety instructions we have provided for your protection. The level of seriousness to be applied to each is explained below:

WARNING

This statement appears where the information **must** be followed **exactly** to avoid **serious personal injury** or **loss of life**.

CAUTION

This statement appears where the information **must** be followed to avoid **minor personal injury** or **damage to this equipment**.

TABLE OF CONTENTS

	Page
Installation	Section A
Technical Specifications	A-1
Safety Precautions	A-2
Location / Ventilation	A-2
Storing	A-2
Stacking	A-2
Angle of Operation	A-2
Lifting	A-3
High Altitude Operation	A-3
High Temperature Operation	A-3
Towing	A-3
Pre-Operation Engine Service	A-4
Oil	A-4
Fuel	A-4
Fuel Cap	A-4
Engine Break-In, Engine Cooling System	A-4
Battery Connection	A-4
Muffler Outlet Pipe	A-5
Spark Arrestor	A-5
Welding Terminals	A-5
Welding Output Cables	A-5
Machine Grounding	A-5
Remote Control	A-6
Auxiliary Power Receptacles	A-6
Standby Power Connections	A-6
Connection of Vantage Premises Wiring	A-7
Connection of Lincoln Electric Wire Feeders	A-8, A-9
<hr/>	
Operation	Section B
Safety Instructions	B-1
General Description	B-1
Recommended Applications	B-1
Controls and Settings	B-2
Engine Controls	B-2
Welder Controls	B-3
Auxiliary Power Controls	B-4
Engine Operation	B-4
Starting The Engine	B-4
Stopping the Engine	B-4
Typical Fuel Consumption	B-5
Welding Operation	B-5
Duty Cycle	B-5
Stick Welding Mode	B-5
CC-Stick Mode	B-5
Downhill Pipe Mode	B-5
Touch Start TIG Mode	B-5
Vantage Settings when using HI-FREQ Unit and TIG Module	B-5
Typical Current Ranges for Tungsten Electrodes	B-6
CV-Wire Mode	B-7
Arc Gouging	B-7
Paralleling	B-7
Auxiliary Power Operation	B-7
Simultaneous Welding and Auxiliary Power Loads	B-7
Simultaneous Welding and Power Loads, Extension Cord Length Recommendations	B-8

TABLE OF CONTENTS

Accessories		Section C
	Optional Field Installed Accessories	C-1

Maintenance		Section D
	Safety Precautions	D-1
	Routine and Periodic Maintenance	D-1
	Engine Maintenance	D-1
	Air Filter	D-1
	Fuel Filters	D-2
	Fuel Pre-Filter/Water Separator Assembly	D-2
	Water Separator	D-2
	Secondary Fuel Filter	D-2
	Cooling System	D-3
	Cooling Blower Belt	D-3
	Battery Handling	D-3
	Charging the Battery	D-4
	Nameplate / Warning Decal Maintenance	D-4
	Welder / Generator Maintenance	D-4
	Engine Maintenance Components	D-4

Troubleshooting		Section E
------------------------	--	------------------

Wiring, Connection Diagrams and Dimension Print		Section F
--	--	------------------

Parts Lists		P-472 Series
--------------------	--	---------------------

TECHNICAL SPECIFICATIONS - Vantage 500 DEUTZ (K2271-1)

INPUT - DIESEL ENGINE					
Make /Model	Description	Speed (RPM)	Displacement	Starting System	Capacities
Deutz F3L 912 Diesel Engine	3 cylinder 44HP (33 kw) @ 1800 RPM	High Idle 1900 Full Load 1800	173 cu. in (2.83L) Bore x Stroke 3.94" x 4.72" (100mm x 120mm)	12VDC battery & Starter	Fuel (25 US gal) 94.6L Oil: 9.5 QTS. 9.0L
RATED OUTPUT @ 104°F(40°C) - WELDER					
Duty Cycle	Welding Output		Volts at Rated Amps		
100%	500 Amps (DC multi-purpose)		40 Volts		
60%	550 Amps (DC multi-purpose)		36 volts		
50%	575 Amps (DC multi-purpose)		35 volts		
OUTPUT @ 104°F(40°C) - WELDER AND GENERATOR					
Welding Range 30 - 575 Amps CC/CV 20 - 250 Amps TIG					
Open Circuit Voltage 60 Max OCV @ 1900 RPM					
Auxiliary Power ⁽¹⁾ 120/240 VAC 12,000 WATTS, 60 Hz.					
PHYSICAL DIMENSIONS					
Height ⁽²⁾	Width	Depth	Weight		
42.0 in (1066.8 mm)	31.5 in. (800.1mm)	63.1 in. (1603mm)	1615 lbs. (733kg) (Approx)		

- Output rating in watts is equivalent to volt-amperes at unity power factor.
Output voltage is within +/- 10% at all loads up to rated capacity. When welding, available auxiliary power will be reduced.
- Top of Enclosure. Add 6.6" (167.6mm) for exhaust.

Vantage 500 DEUTZ

Read this entire installation section before you start installation.

SAFETY PRECAUTIONS



WARNING

Do not attempt to use this equipment until you have thoroughly read all operating and maintenance manuals supplied with your machine. They include important safety precautions, detailed engine starting, operating and maintenance instructions and parts lists.

ELECTRIC SHOCK can kill.



- Do not touch electrically live parts such as output terminals or internal wiring.
- Insulate yourself from the work and ground.
- Always wear dry insulating gloves.

ENGINE EXHAUST can kill.



- Use in open, well ventilated areas or vent exhaust outside

MOVING PARTS can injure.



- Do not operate with doors open or guards off.
- Stop engine before servicing.
- Keep away from moving parts

Only qualified personnel should install, use or service this equipment.

LOCATION / VENTILATION

The welder should be located to provide an unrestricted flow of clean, cool air to the cooling air inlets and to avoid restricting the cooling air outlets. Also, locate the welder so that the engine exhaust fumes are properly vented to an outside area.



CAUTION

DO NOT MOUNT OVER COMBUSTIBLE SURFACES

Where there is a combustible surface directly under stationary or fixed electrical equipment, that surface should be covered with a steel plate at least .06"(1.6mm) thick, which should extend not less than 5.90"(150mm) beyond the equipment on all sides.

STORING

1. Store the machine in a cool, dry place when it is not in use. Protect it from dust and dirt. Keep it where it can't be accidentally damaged from construction activities, moving vehicles, and other hazards.
2. Drain the engine oil and refill with fresh 10W30 oil. Run the engine for about five minutes to circulate oil to all the parts. See the MAINTENANCE section of this manual for details on changing oil.
3. Remove the battery, recharge it, and adjust the electrolyte level. Store the battery in a dry, dark place.

STACKING

Vantage machines cannot be stacked.

ANGLE OF OPERATION

To achieve optimum engine performance the Vantage should be run in a level position. The maximum angle of operation for the Deutz engine is 30 degrees fore and aft, 40 degrees right and 45 degrees left. If the engine is to be operated at an angle, provisions must be made for checking and maintaining the oil level at the normal (FULL) oil capacity in the crankcase. When operating the welder at an angle, the effective fuel capacity will be slightly less than the specified 25 gallons.

LIFTING

The Vantage lift bale should be used to lift the machine. The Vantage is shipped with the lift bale retracted. Before attempting to lift the Vantage the lift bale must be secured in a raised position. Secure the lift bale as follows:

- Open the engine compartment door.
- Locate the 2 access holes on the upper middle region of compartment wall just below the lift bale.
- Use the lifting strap to raise the lift bale to the full upright position. This will align the mounting holes on the lift bale with the access holes.
- Secure the lift bale with 2 thread forming screws. The screws are provided in the shipped loose parts bag.



WARNING



- **Lift only with equipment of adequate lifting capacity.**
- **Be sure machine is stable when lifting.**
- **Do not lift this machine using lift bale if it is equipped with a heavy accessory such as trailer or gas cylinder.**

FALLING EQUIPMENT can cause injury.

- **Do not lift machine if lift bale is damaged.**
- **Do not operate machine while suspended from lift bale.**

HIGH ALTITUDE OPERATION

At higher altitudes, output derating may be necessary. For maximum rating, derate the welder output 5% for every 300 meters (984 ft.) above 1500 meters (4920 ft.). For output of 500A and below, derate the welder output 5% for every 300 meters (984 ft.) above 2100 meters (6888 ft.).

Contact a Deutz Service Representative for any engine adjustments that may be required.

HIGH TEMPERATURE OPERATION

At temperatures above 40°C (104°F), output voltage derating may be necessary. For maximum output current ratings, derate welder voltage rating 2 volts for every 10°C (21°F) above 40°C (104°F).

TOWING

The recommended trailer for use with this equipment for road, in-plant and yard towing by a vehicle ⁽¹⁾ is Lincoln's K953-1. If the user adapts a non-Lincoln trailer, he must assume responsibility that the method of attachment and usage does not result in a safety hazard nor damage the welding equipment. Some of the factors to be considered are as follows:

- Design capacity of trailer vs. weight of Lincoln equipment and likely additional attachments.
- Proper support of, and attachment to, the base of the welding equipment so that there will be no undue stress to the trailer's framework.
- Proper placement of the equipment on the trailer to insure stability side to side and front to back when being moved and when standing by itself.
- Typical conditions of use, such as travel speed, roughness of surface on which the trailer will be operated, and environmental conditions.
- Proper preventative maintenance of trailer.
- Conformance with federal, state and local laws ⁽¹⁾.

⁽¹⁾ Consult applicable federal, state and local laws regarding specific requirements for use on public highways.

VEHICLE MOUNTING



WARNING

Improperly mounted concentrated loads may cause unstable vehicle handling and tires or other components to fail.

- **Only transport this Equipment on serviceable vehicles which are rated and designed for such loads.**
- **Distribute, balance and secure loads so vehicle is stable under conditions of use.**
- **Do not exceed maximum rated loads for components such as suspension, axles and tires.**
- **Mount equipment base to metal bed or frame of vehicle.**
- **Follow vehicle manufacture's instructions.**

PRE-OPERATION ENGINE SERVICE

READ the engine operating and maintenance instructions supplied with this machine.



WARNING



Stop engine while fueling.

- **Do not smoke when fueling.**
- **Keep sparks and flame away from tank.**
- **Do not leave unattended while fueling.**
- **Wipe up spilled fuel and allow fumes to clear before starting engine.**
- **Do not overfill tank, fuel expansion may cause overflow.**

DIESEL FUEL
can cause fire.

• **Wipe up spilled fuel and allow fumes to clear before starting engine.**

• **Do not overfill tank, fuel expansion may cause overflow.**

DIESEL FUEL ONLY

OIL



The Vantage is shipped with the engine crankcase filled with high quality SAE 10W-30 oil (API class CD or better). Check the oil level before starting the engine. If it is not up to the full mark on the dip stick, add oil as required. Check the oil level every four hours of running time during the first 35 running hours. Refer to the engine Operator's Manual for specific oil recommendations and break-in information. The oil change interval is dependent on the quality of the oil and the operating environment. Refer to the engine Operator's Manual for the proper service and maintenance intervals.

FUEL USE DIESEL FUEL ONLY



Fill the fuel tank with clean, fresh diesel fuel. The capacity of the fuel tank is approx 95 liters. See engine Operator's Manual for specific fuel recommendations. **Running out of fuel may require bleeding the fuel injection pump.** NOTE: Before starting the engine, open the fuel shutoff valve (pointer to be in line with hose).

FUEL CAP

Remove the plastic cap covering from the Fuel Tank Filler neck and install the Fuel Cap.

ENGINE BREAK-IN

Lincoln Electric selects high quality, heavy-duty industrial engines for the portable welding machines we offer. While it is normal to see a small amount of crankcase oil consumption during initial operation, excessive oil use, wetstacking (oil or tar like substance at the exhaust port), or excessive smoke is not normal.

Larger machines with a capacity of 350 amperes and higher, which are operated at low or no-load conditions for extended periods of time are especially susceptible to the conditions described above. To accomplish successful engine break-in, most diesel-powered equipment needs only to be run at a reasonably heavy load within the rating of the welder for some period of time during the engine's early life. However, if the welder is subjected to extensive light loading, occasional moderate to heavy loading of the engine may sometimes be necessary. Caution must be observed in correctly loading a diesel/generator unit.

1. Connect the welder output studs to a suitable resistive load bank. Note that any attempt to short the output studs by connecting the welding leads together, direct shorting of the output studs, or connecting the output leads to a length of steel will result in catastrophic damage to the generator and voids the warranty.
2. Set the welder controls for an output current and voltage within the welder rating and duty cycle. Note that any attempt to exceed the welder rating or duty cycle for any period of time will result in catastrophic damage to the generator and voids the warranty.
3. Periodically shut off the engine and check the crankcase oil level.

ENGINE COOLING SYSTEM

The Deutz engine is air cooled by a belt driven axial blower. The oil cooler and engine cooling fins should be blown out with compressed air or steam to maintain proper cooling (See the engine Owners Manual for procedures and frequency).

BATTERY CONNECTION



WARNING



GASES FROM BATTERY can explode.

- **Keep sparks, flame and cigarettes away from battery.**

To prevent EXPLOSION when:

- **INSTALLING A NEW BATTERY — disconnect negative cable from old battery first and connect to new battery last.**
- **CONNECTING A BATTERY CHARGER — remove battery from welder by disconnecting negative cable first, then positive cable and battery clamp. When reinstalling, connect negative cable last. Keep well ventilated.**
- **USING A BOOSTER — connect positive lead to battery first then connect negative lead to negative battery lead at engine foot.**



BATTERY ACID can burn eyes and skin.

- **Wear gloves and eye protection and be careful when working near battery.**
- **Follow instructions printed on battery.**

IMPORTANT: To prevent ELECTRICAL DAMAGE WHEN:

- a) Installing new batteries.
- b) Using a booster.

Use correct polarity — Negative Ground.

Vantage 500 DEUTZ



The Vantage is shipped with the negative battery cable disconnected. Before you operate the machine, make sure the Engine Switch is in the OFF position and attach the disconnected cable securely to the negative (-) battery terminal.

Remove the insulating cap from the negative battery terminal. Replace and tighten negative battery cable terminal. NOTE: This machine is furnished with a wet charged battery; if unused for several months, the battery may require a booster charge. Be sure to use the correct polarity when charging the battery.

MUFFLER OUTLET PIPE

Remove the plastic plug covering the muffler outlet tube. Using the clamp provided secure the outlet pipe to the outlet tube with the pipe positioned such that it will direct the exhaust in the desired position.

SPARK ARRESTOR

Some federal, state or local laws may require that petrol or diesel engines be equipped with exhaust spark arrestors when they are operated in certain locations where unarrested sparks may present a fire hazard. The standard muffler included with this welder does not qualify as a spark arrestor. When required by local regulations, a suitable spark arrestor, must be installed and properly maintained.



An incorrect arrestor may lead to damage to the engine or adversely affect performance.

WELDING TERMINALS

The Vantage is equipped with a toggle switch for selecting "hot" welding terminals when in the "WELD TERMINALS ON" position or "cold" welding terminals when in the "REMOTELY CONTROLLED" position.

WELDING OUTPUT CABLES

With the engine off, route the electrode and work cables thru the strain relief bracket provided on the front of the base and connect to the terminals provided. These connections should be checked periodically and tightened if necessary.

Listed in Table A.1 are copper cable sizes recommended for the rated current and duty cycle. Lengths stipulated are the distance from the welder to work and back to the welder again. Cable sizes are increased for greater lengths primarily for the purpose of minimizing cable voltage drop.

Table A.1 Combined Length of Electrode and Work Cables.

AMPS @ 100% Duty Cycle	TOTAL COMBINED LENGTH OF ELECTRODE AND WORK CABLES		
	Up to 150ft	150-200ft	200-250ft
500	3/0 AWG	3/0 AWG	4/0 AWG

MACHINE GROUNDING

Because this portable engine driven welder creates its own power, it is not necessary to connect its frame to an earth ground, unless the machine is connected to premises wiring (home, shop, etc.).

To prevent dangerous electric shock, other equipment powered by this engine driven welder must:

a) be grounded to the frame of the welder using a grounding type plug,

or

b) be double insulated.

When this welder is mounted on a truck or trailer, its frame must be securely connected to the metal frame of the vehicle. When this engine driven welder is connected to premises wiring such as that in a home or shop, its frame must be connected to the system earth ground. See further connection instructions in the section entitled "Standby Power Connections" as well as the article on grounding in the latest National Electrical Code and the local codes.

In general, if the machine is to be grounded, it should be connected with a #8 or larger copper wire to a solid earth ground such as a metal ground stake going into the ground for at least 10 Feet or to the metal framework of a building which has been effectively grounded. The National Electric Code lists a number of alternate means of grounding electrical equipment. A machine grounding stud marked with the symbol  is provided on the front of the welder.

REMOTE CONTROL

OUTPUT

The Vantage is equipped with a 6-pin and a 14-pin connector. The 6-pin connector is for connecting the K857 or K857-1 Remote Control or for TIG welding, the K870 foot Amptrol or the K936-2 hand Amptrol. When in the CC-STICK, DOWNHILL PIPE, or CV-WIRE modes and when a remote control is connected to the 6-pin Connector, the auto-sensing circuit automatically switches the OUTPUT control from control at the welder to remote control.

When in TOUCH START TIG mode and when a Amptrol is connected to the 6-Pin Connector, the OUTPUT dial is used to set the maximum current range of the CURRENT CONTROL of the Amptrol.

The 14-pin connector is used to directly connect a wire feeder control cable. In the CV-WIRE mode, when the control cable is connected to the 14-pin connector, the auto-sensing circuit automatically makes the Output Control inactive and the wire feeder voltage control active.

NOTE: When a wire feeder with a built in welding voltage control is connected to the 14-pin connector, do not connect anything to

AUXILIARY POWER RECEPTACLES

The auxiliary power capacity of the Vantage is 12,000 watts of 60 Hz, single phase power. The auxiliary power capacity rating in watts is equivalent to volt-amperes at unity power factor. The maximum permissible current of the 240 VAC output is 50 A. The 240 VAC output can be split to provide two separate 120 VAC outputs with a maximum permissible current of 50 A per output to two separate 120 VAC branch circuits. The output voltage is within $\pm 10\%$ at all loads up to rated capacity.

The Vantage has two 20 Amp-120VAC (5-20R) GFCI duplex receptacles and one 50 Amp-120/240 VAC (14-50R) receptacle. The 120/240 VAC receptacle can be split for single phase 120 VAC operation. The auxiliary power receptacles should only be used with three wire grounded type plugs or approved double insulated tools with two wire plugs. The current rating of any plug used with the system must be at least equal to the current capacity of the associated receptacle.

NOTE: The two 120V GFCI receptacles and the two 120 volt circuits of the 120/240V receptacle are connected to different phases and can not be paralleled.

STANDBY POWER CONNECTIONS

The Vantage is suitable for temporary, standby or emergency power using the engine manufacturer's recommended maintenance schedule.

The Vantage can be permanently installed as a standby power unit for 240 volt-3 wire, 50 amp service. Connections must be made by a licensed electrician who can determine how the 120/240 VAC (60Hz) power can be adapted to the particular installation and comply with all applicable electrical codes. The following information can be used as a guide by the electrician for most applications. Refer to the connection diagram shown in Figure A.2.

1. Install the double-pole, double-throw switch between the power company meter and the premises disconnect.

Switch rating must be the same or greater than the customer's premises disconnect and service over current protection.

2. Take necessary steps to assure load is limited to the capacity of the Vantage by installing a 50 amp, 240 VAC double pole circuit breaker. Maximum rated load for each leg of the 240 VAC auxiliary is 50 amps. Loading above the rated output will reduce output voltage below the allowable -10% of rated voltage which may damage appliances or other motor-driven equipment and may result in overheating of the Vantage engine.

3. Install a 50 amp 120/240 VAC plug (NEMA Type 14-50) to the double-pole circuit breaker using No. 6, 4 conductor cable of the desired length. (The 50 amp, 120/240 VAC plug is available in the optional K802R plug kit.)

4. Plug this cable into the 50 Amp 120/240 Volt receptacle on the Vantage case front.

Figure A.2 Connection of the Vantage to Premises Wiring

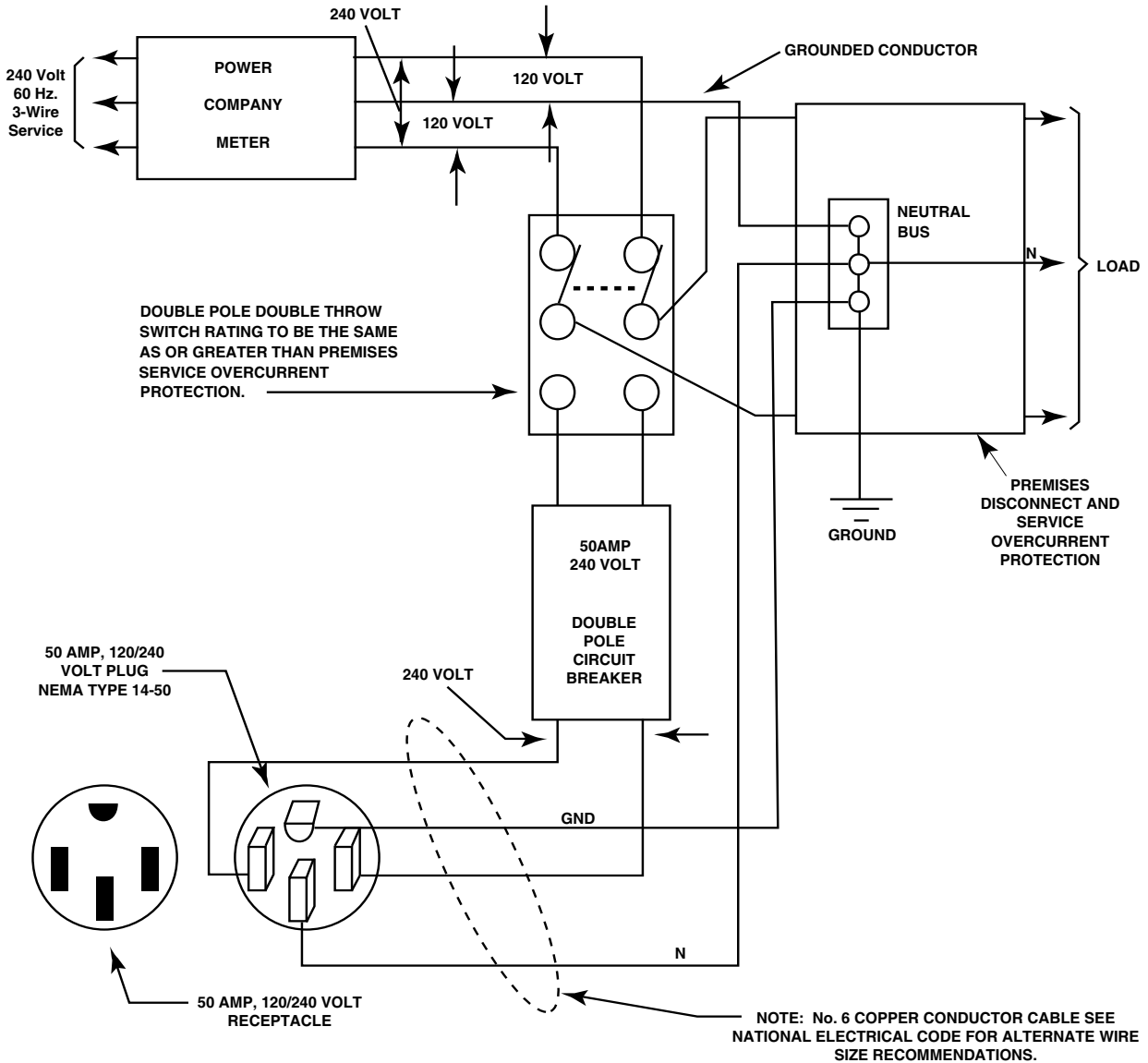

CONNECTION OF LINCOLN ELECTRIC WIRE FEEDERS



Shut off welder before making any electrical connections.

CONNECTION OF LN-7, LN-8 OR LN-742 TO THE VANTAGE

- Shut the welder off.
- Connect the LN-7, LN-8 or LN-742 per instructions on the appropriate connection diagram in the DIAGRAMS section.
- Set the "WIRE FEEDER VOLTMETER" switch to either "+" or "-" as required by the electrode being used.
- Set the "SELECTOR" switch to the "CV-WIRE" position.
- Adjust the "ARC CONTROL" knob to desired Crispness. SOFT for MIG and CRISP for INNERSHIELD.
- Set the "WELDING TERMINALS" switch to the "REMOTELY CONTROLLED" position.

CONNECTION OF LN-15 TO THE VANTAGE

These connections instructions apply to both the LN-15 Across-The-Arc and Control Cable models. The LN-15 has an internal contactor and the electrode is not energized until the gun trigger is closed. When the gun trigger is closed the wire will begin to feed and the welding process is started.

- Shut the welder off.
- For electrode Positive, connect the electrode cable to the "+" terminal of the welder and work cable to the "-" terminal of the welder. For electrode Negative, connect the electrode cable "-" terminal of the welder and work cable to the "+" terminal of the welder.
- **Across-The-Arc Model:**
Attach the single lead from the front of the LN-15 to work using the spring clip at the end of the lead. This is a control lead to supply current to the wire feeder motor; it does not carry welding current.
- **Control Cable Model:**
Connect Control Cable between Engine Welder and Feeder.
- Set the MODE switch to the "CV-WIRE " position.
- **Across-The-Arc Model:**
Set the "WELD TERMINALS" switch to "WELD TERMINALS ON"
- **Control Cable Model:**
Set the "WELD TERMINALS" switch to "REMOTELY CONTROLLED"
- Set the "WIRE FEEDER VOLTMETER" switch to either "+" or "-" as required by the electrode polarity being used.
- Set the "ARC CONTROL" knob to "0" initially and adjust to suit.

CONNECTION OF AN LN-23P WIRE FEEDER TO THE VANTAGE

- Shut the welder off.
- Connect the LN-23P per instructions on the appropriate connection diagram in the DIAGRAMS section. (NOTE): When connecting an LN-23P to the Vantage , a K350-1 adapter kit must be used.
- Set the "WIRE FEEDER VOLTMETER" switch to "-".
- Set the "SELECTOR" switch to "CV-WIRE" position.
- Set the "WELDING TERMINALS" switch to "REMOTELY CONTROLLED".
- Set the ARC CONTROL to desired crispness.
- If you are using an LN-23P with the K350-1 adapter kit, the electrode is not energized until the gun trigger is closed.

CONNECTION OF THE LN-25 TO THE VANTAGE

The LN-25 with or without an internal contactor may be used with the Vantage. See the appropriate connection diagram in the DIAGRAMS section.

NOTE: The LN-25 (K431) Remote Control Module and (K432) Remote Cable are not recommended for use with the Vantage.

- Shut the welder off.
- For electrode Positive, connect the electrode cable from the LN-25 to the "+" terminal of the welder and work cable to the "-" terminal of the welder. For electrode Negative, connect the electrode cable from the LN-25 to the "-" terminal of the welder and work cable to the "+" terminal of the welder.
- Attach the single lead from the front of the LN-25 to work using the spring clip at the end of the lead. This is a sense lead to supply current to the wire feeder motor; it does not carry welding current.
- Set the SELECTOR switch to the "CV-WIRE" position.
- Set the "WELDING TERMINALS" switch to "WELD TERMINALS ON"
- Adjust the "ARC CONTROL" knob to desired crispness. Generally, welding is best if the "ARC CONTROL" is set to SOFT for MIG and CRISP for INNERSHIELD. You may however, want to start in the middle and adjust (as needed) from there.
- If you are using an LN-25 with an internal contactor, the electrode is not energized until the gun trigger is closed.

CAUTION

If you are using an LN-25 without an internal contactor, the electrode will be energized when the Vantage is started.

- When the gun trigger is closed, the current sensing circuit will cause the wire to begin to feed and the welding process is started.

CONNECTION OF AN NA-3 AUTOMATIC WELDING SYSTEM TO THE VANTAGE

For connection diagrams and instructions for connecting an NA-3 Welding System to the Vantage, refer to the NA-3 Welding System instruction manual. The connection diagram for the LN-8 can be used for connecting the NA-3.

CONNECTION OF PRINCE XL SPOOL GUN TO THE VANTAGE

Connection of the Prince XL Spool Gun requires the use of the K1849-1 Adapter Module.

- Shut the Welder off.
- For electrode Positive, connect the electrode cable to the "+" terminal of the welder and work cable to the "-" terminal of the welder. For electrode Negative, connect the electrode cable "-" terminal of the welder and work cable to the "+" terminal of the welder.
- Connect the Control Cable of the Spool Gun to the Adapter Module and connect the Control Cable of the Adapter Module to the Welder.
- Connect the Gas Hose.
- Set the MODE switch to the "CV-WIRE" position.
- Set the "WELD TERMINALS" switch to "WELD TERMINALS ON".
- Set the "ARC CONTROL" knob to "0" initially and adjust to suit.

SAFETY INSTRUCTIONS

Read and understand this entire section before operating your Vantage.



Do not attempt to use this equipment until you have thoroughly read all operating and maintenance manuals supplied with your machine. They include important safety precautions, detailed engine starting, operating and maintenance instructions and parts lists.

ELECTRIC SHOCK can kill.



- Do not touch electrically live parts such as output terminals or internal wiring.
- Insulate yourself from the work and ground.
- Always wear dry insulating gloves.

ENGINE EXHAUST can kill.



- Use in open, well ventilated areas or vent exhaust outside
- Do not stack anything near the engine.

MOVING PARTS can injure.



- Do not operate with doors open or guards off.
- Stop engine before servicing.
- Keep away from moving parts

Only qualified personnel should operate this equipment.

ADDITIONAL SAFETY PRECAUTIONS

Always operate the welder with the hinged door closed and the side panels in place as these provide maximum protection from moving parts and insure proper cooling air flow.

GENERAL DESCRIPTION

The Vantage is a diesel engine-driven welding power source. The machine uses a brush type alternating current generator for DC multi-purpose welding and for 120/240 VAC auxiliary standby power. The welding control system uses state of the art **Chopper Technology™**.

RECOMMENDED APPLICATIONS

WELDER

The Vantage provides excellent constant current DC welding output for stick (SMAW) and TIG welding. The Vantage also provides excellent constant voltage DC welding output for MIG (GMAW), Innershield (FCAW), Outershield (FCAW-G) and Metal Core welding. In addition the Vantage can be used for Arc Gouging with carbons up to 3/8"(10mm) in diameter.

The Vantage is **not recommended** for pipe thawing.

GENERATOR

The Vantage provides smooth 120/240 VAC output for auxiliary power and emergency standby power.

CONTROLS AND SETTINGS

All welder and engine controls are located on the case front panel. Refer to Figure B.1 and the explanations that follow.

Figure B.1 Case Front Panel Controls

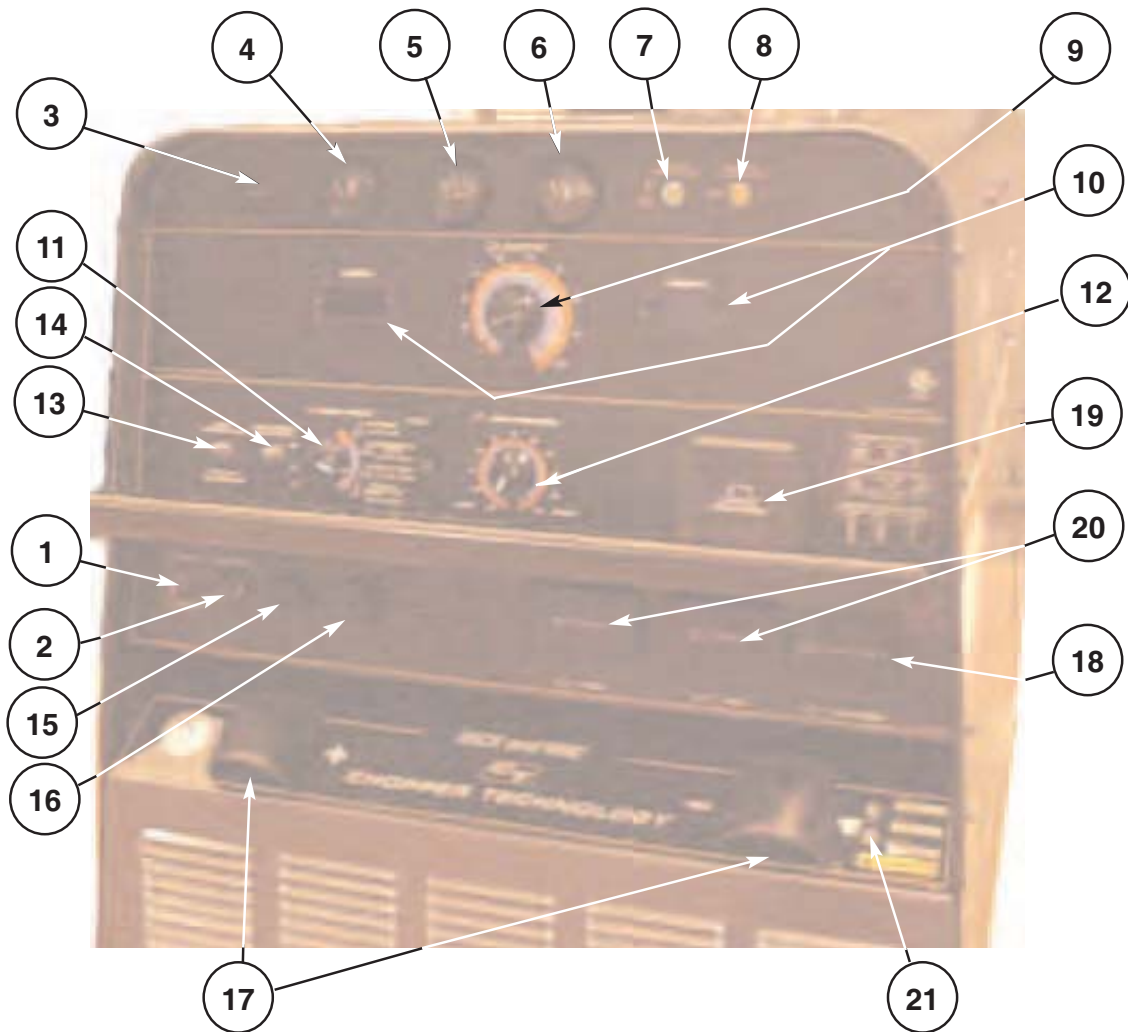

ENGINE CONTROLS (Items 1 through 8)

1. RUN STOP SWITCH

Toggling the switch to the RUN position energizes the fuel solenoid for approximately 30 seconds. The engine must be started within that time or the fuel solenoid will deenergize, and the switch must be toggled to reset the timer.

2. START PUSHBUTTON

Energizes the starter motor to crank the engine. With the engine "Run / Stop" switch in the "Run" position, push and hold the Start button to crank the engine; release as the engine starts. Do not press while engine is running since this can cause damage to the ring gear and/or starter motor.

3. HOUR METER

The hour meter displays the total time that the engine has been running. This meter is a useful indicator for scheduling preventive maintenance.

4. FUEL LEVEL GAUGE

Displays the level of diesel fuel in the fuel tank.



The operator must watch the fuel level closely to prevent running out of fuel and possibly having to bleed the system.

5. ENGINE TEMPERATURE GAUGE

The gauge displays the engine oil temperature.



Vantage 500 DEUTZ

LINCOLN[®]
ELECTRIC

6. OIL PRESSURE GAUGE



The gauge displays the engine oil pressure when the engine is running.

7. ENGINE PROTECTION

The yellow engine protection light remains off with proper oil pressure and under normal operating temperatures. If the light turns on, the engine protection system will stop the engine. Check for proper oil level and add oil if necessary. Check for loose or disconnected leads at the oil pressure sender located on the engine. The light will remain on when the engine has been shut down due to low oil pressure or over-temperature condition.

8. BATTERY CHARGING LIGHT



The yellow engine alternator light is off when battery charging system is functioning normally. If light turns on, the engine protection system will shut down the engine. Check the Engine cooling blower belt. Also the alternator or the voltage regulator may not be operating correctly. The light may also come on due to a faulty flashing circuit. The light will remain on when the engine is stopped and the run/stop switch is in the run position.

WELDING CONTROLS (Items 9 through 17)

9. OUTPUT CONTROL: The OUTPUT dial is used to preset the output voltage or current as displayed on the digital meters for the four welding modes. When in the CC-STICK, DOWNHILL PIPE or CV-WIRE modes and when a remote control is connected to the 6-Pin or 14-Pin Connector, the auto-sensing circuit automatically switches the OUTPUT CONTROL from control at the welder to the remote control. In the CV-WIRE mode, when the wire feeder control cable is connected to the 14-pin connector the auto-sensing circuit automatically makes OUTPUT CONTROL inactive and the wire feeder voltage control active.

When in the TOUCH START TIG mode and when a Amptronic is connected to the 6-pin Connector, the OUTPUT dial is used to set the maximum current range of the CURRENT CONTROL of the Amptronic.

10. DIGITAL OUTPUT METERS:

The digital meters allow the output voltage (CV-WIRE mode) or current (CC-STICK, DOWNHILL PIPE and TIG modes) to be set prior to welding using the OUTPUT control knob. During welding, the meters display the actual output voltage (VOLTS) and current (AMPS). A memory feature holds the display of both meters on the seven seconds after welding is stopped. This allows the operator to read the actual current and voltage just prior to when welding was ceased. While the display is being held the left-most decimal point in each display will be flashing. The accuracy of the meters is $\pm 3\%$.

11. WELD MODE SELECTOR SWITCH:

(Provides four selectable welding modes)

- CV-WIRE
- DOWNHILL PIPE
- CC-STICK
- TOUCH START TIG

12. ARC CONTROL:

The ARC CONTROL WIRE/STICK knob is active in the WIRE and STICK modes, and has different functions in these modes. This control is not active in the TIG mode.

CC-STICK mode: In this mode, the ARC CONTROL knob sets the short circuit current (arc-force) during stick welding. Increasing the number from -10 (Soft) to +10 (Crisp) increases the short circuit current and prevents sticking of the electrode to the plate while welding. This can also increase spatter. It is recommended that the ARC CONTROL be set to the minimum number without electrode sticking. Start with a setting at 0.

DOWNHILL PIPE mode: In this mode, the ARC CONTROL knob sets the short circuit current (arc-force) during stick welding to adjust for a soft or a more forceful digging arc (Crisp). Increasing the number from -10 (Soft) to +10 (Crisp) increases the short circuit current which results in a more forceful digging arc. Typically a forceful digging arc is preferred for root and hot passes. A softer arc is preferred for fill and cap passes where weld puddle control and deposition ("stacking" of iron) are key to fast travel speeds. It is recommended that the ARC CONTROL be set initially at 0.

CV-WIRE mode: In this mode, turning the ARC CONTROL knob from -10(soft) to +10(crisp) changes the arc from soft and washed-in to crisp and narrow. It acts as an inductance/pinch control. The proper setting depends on the procedure and operator preference. Start with a setting of 0.

13. WELDING TERMINALS SWITCH

In the WELD TERMINALS ON position, the output is electrically hot all the time. In the REMOTELY CONTROLLED position, the output is controlled by a wire feeder or amptronic device, and is electrically off until a remote switch is depressed.

14. WIRE FEEDER VOLTMETER SWITCH:

Matches the polarity of the wire feeder voltmeter to the polarity of the electrode.

15. 6 - PIN CONNECTOR

For attaching optional remote control equipment. Includes auto-sensing remote control circuit.

16. 14 - PIN CONNECTOR

For attaching wire feeder control cables. Includes contactor closure circuit, auto-sensing remote control circuit, and 120VAC and 42VAC power.

NOTE: When a wire feeder with a built in welding voltage control is connected to the 14-pin connector, do not connect anything to the 6-pin connector.

17. WELD OUTPUT TERMINALS + AND -

These 1/2 - 13 studs with flange nuts provide welding connection points for the electrode and work cables. For positive polarity welding the electrode cable connects to the "+" terminal and the work cable connects to this "-" terminal. For negative polarity welding the work cable connects to the "+" terminal and the electrode cable connects to this "-" terminal.

AUXILIARY POWER CONTROLS

(Items 18-21)

18. 120/240 VAC RECEPTACLE

This is a 120/240VAC (14-50R) receptacle that provides 240VAC or can be split for 120VAC single phase auxiliary power. This receptacle has a 50 amp rating. Refer to the AUXILIARY POWER RECEPTACLES section in the installation chapter for further information about this receptacle. Also refer to the AUXILIARY POWER OPERATION section later in this chapter.

19. CIRCUIT BREAKERS

These circuit breakers provide separate overload current protection for each 120V circuit at the 240V receptacle, each 120V receptacle, the 120VAC in the 14-Pin connector, the 42VAC in the 14-Pin connector and battery circuit overload protection.

20. 120VAC GFCI RECEPTACLES

These two 120VAC (5-20R) receptacles with ground fault circuit interruption protection provide 120VAC for auxiliary power. Each receptacle has a 20 amp total rating. They are designed to protect the user from the hazards of ground faults. When the GFCI has tripped there will be no voltage available from the receptacle. If the GFCI has tripped, any device plugged into the GFCI receptacle should be unplugged and the reason for tripping the GFCI should be determined. If the device is found to be damaged or defective, it should be repaired or replaced before any further use. The GFCI should be checked for proper operation prior to each use by pressing the test button. The GFCI can be reset by pushing the reset button. Refer to the AUXILIARY POWER RECEPTACLES section in the installation chapter for further information about these receptacles. Also refer to the AUXILIARY POWER OPERATION section later in this chapter.

21. GROUND STUD

Provides a connection point for connecting the machine case to earth ground. Refer to "MACHINE GROUNDING" in the Installation chapter for proper machine grounding information.

ENGINE OPERATION**STARTING THE ENGINE**

1. Open the engine compartment door and check that the fuel shutoff valve located to the left of the fuel filter housing is in the open position (lever to be in line with the hose).
2. Check for proper oil level. Close engine compartment door.
3. Remove all plugs connected to the AC power receptacles.
4. Set the RUN/STOP switch to "RUN". Observe that the engine protection and battery charging lights are on. After 10 seconds, the engine protection light will turn off.
5. Within 30 seconds, press and hold the engine START button until the engine starts.
6. Release the engine START button when the engine starts.
7. Check that the engine protection and battery charging lights are off. The engine protection light is on after starting, the engine will shutdown in a few seconds. Investigate any indicated problem.
8. Allow the engine to warm up for several minutes before applying a load. Allow a longer warm up time in cold weather.

COLD WEATHER STARTING

With a fully charged battery and the proper weight oil, the engine should start satisfactorily even down to about 0°F. If the engine must be frequently started below 10°F, it may be desirable to install the optional ether start kit (K825-1). Installation and operating instructions are included in the kit.

STOPPING THE ENGINE

1. Switch the RUN/STOP switch to "STOP". This turns off the voltage supplied to the shutdown solenoid. A backup shutdown can be accomplished by shutting off the fuel valve located on the fuel line.

TYPICAL FUEL CONSUMPTION

Refer to Table B.2 for typical fuel consumption of the Vantage Engine for various operating scenarios.

Table B.2
Deutz F3L912 Engine Fuel Consumption

	Deutz B3.3 44HP(33Kw) @ 1800 RPM	Running Time for 25Gal.(94.6 L) (Hours)
High Idle - no load 1900 RPM	.66 Gal./hour (2.50 Lts./hour)	37.9
DC CC Weld Output 500 Amps @ 40 Volts	1.94 Gal./hour (7.34 Lts./hour)	12.9
Auxiliary Power 12,000 VA	1.31 Gal./hour (4.96 Lts./hour)	19.1

WELDER OPERATION

DUTY CYCLE

Duty Cycle is the ratio of the uninterrupted on-load duration to 10 minutes. The total time period of one complete on-load and no-load cycle is 10 minutes. For example, in the case of a 60% duty cycle, load is applied continuously for 6 minutes followed by a no-load period of 4 minutes.

STICK WELDING MODE

The Vantage can be used with a broad range of DC stick electrodes.

The MODE switch provides two stick welding settings as follows:

CC-STICK MODE

The CC-STICK position of the MODE switch is designed for horizontal, vertical-up and overhead welding with all types of electrodes, especially low hydrogen. The OUTPUT CONTROL knob adjusts the full output range for stick welding.

The ARC CONTROL knob sets the short circuit (arc-force) current during stick welding. Increasing the number from -10 (Soft) to +10 (Crisp) increases the short circuit current and prevents sticking of the electrode to the plate while welding. This can also increase spatter. It is recommended that the ARC CONTROL be set to the minimum number without electrode sticking. Start with the knob set at 0.

DOWNHILL PIPE MODE

This slope controlled setting is intended for "out-of-position" and "down hill" pipe welding where the operator would like to control the current level by changing the arc length. The OUTPUT CONTROL knob adjusts the full output range for pipe welding.

The ARC CONTROL knob sets the short circuit current (arc-force) during stick welding to adjust for a soft or a more forceful digging arc (Crisp). Increasing the number from -10 (Soft) to +10 (Crisp) increases the short circuit current which results in a more forceful digging arc. Typically a forceful digging arc is preferred for root and hot passes. A softer arc is preferred for fill and cap passes where weld puddle control and deposition ("stacking" of iron) are key to fast travel speeds. It is recommended that the ARC CONTROL be set initially at 0.

TOUCH START TIG MODE

The Vantage can be used in a wide variety of DC TIG welding applications.

The TOUCH START TIG setting of the MODE switch is for DC TIG (Tungsten Inert Gas) welding. To initiate a weld, the OUTPUT CONTROL knob is first set to the desired current and the tungsten is touched to the work. During the time the tungsten is touching the work there is very little voltage or current and, in general, avoids tungsten contamination. Then, the tungsten is gently lifted off the work in a rocking motion, which establishes the arc.

To stop the arc, simply lift the TIG torch away from the work piece. When the arc voltage reaches approximately 30 volts, the arc will go out and the machine will automatically reset to the touch start current level. The tungsten may then be retouched to the work piece to restrike the arc. The arc may also be started and stopped with an Amptrol or Arc Start Switch.

The ARC CONTROL is not active in the TIG mode.

In general the 'Touch Start' feature avoids tungsten contamination without the use of a Hi-frequency unit. If the use of a high frequency generator is desired, the K930-2 TIG Module can be used with the Vantage. The settings are for reference.

The Vantage is equipped with the required R.F. bypass circuitry for the connection of high frequency generating equipment.

The Vantage and any high frequency generating equipment must be properly grounded. See the K930-2 TIG Module operating manuals for complete instructions on installation, operation, and maintenance.

When using the TIG Module, the OUTPUT control on the Vantage is used to set the maximum range of the CURRENT CONTROL on the TIG Module or an Amptrol if connected to the TIG Module.

VANTAGE SETTINGS WHEN USING THE K930-2 TIG MODULE

- Set the WELD MODE switch to the setting.
- Set the WELDING TERMINALS switch to the "Remotely Controlled" position. This will keep the solid state contactor open and provide a "cold" electrode until the triggering device (Amptrol or Arc Start Switch) is pressed.

**Table B.3 TYPICAL CURRENT RANGES ⁽¹⁾
FOR TUNGSTEN ELECTRODES ⁽²⁾**

Tungsten Electrode Diameter mm (in)	DCEN (-)	DCEP (+)	Approximate Argon Gas Flow Rate l/min (c.f.m.)		TIG TORCH Nozzle Size (4), (5)
	1%, 2% Thoriated Tungsten	1%, 2% Thoriated Tungsten	Aluminum	Stainless Steel	
.25 (0.010)	2-15	(3)	2-4 (3-8)	2-4 (3-8)	#4, #5, #6
.50 (0.020)	5-20	(3)	3-5 (5-10)	3-5 (5-10)	
1.0 (0.040)	15-80	(3)	3-5 (5-10)	3-5 (5-10)	
1.6 (1/16)	70-150	10-20	3-5 (5-10)	4-6 (9-13)	#5, #6
2.4 (3/32)	150-250	15-30	6-8 (13-17)	5-7 (11-15)	#6, #7, #8
3.2 (1/8)	250-400	25-40	7-11 (15-23)	5-7 (11-15)	
4.0 (5/32)	400-500	40-55	10-12 (21-25)	6-8 (13-17)	#8, #10
4.8 (3/16)	500-750	55-80	11-13 (23-27)	8-10 (18-22)	
6.4 (1/4)	750-1000	80-125	13-15 (28-32)	11-13 (23-27)	

(1) When used with argon gas. The current ranges shown must be reduced when using argon/helium or pure helium shielding gases.

(2) Tungsten electrodes are classified as follows by the American Welding Society (AWS):

Pure	EWP
1% Thoriated	EWTh-1
2% Thoriated	EWTh-2

Though not yet recognized by the AWS, Ceriated Tungsten is now widely accepted as a substitute for 2% Thoriated Tungsten in AC and DC applications.

(3) DCEP is not commonly used in these sizes.

(4) TIG torch nozzle "sizes" are in multiples of 1/16ths of an inch:

# 4 =	1/4 in.	6 mm
# 5 =	5/16 in.	8 mm
# 6 =	3/8 in.	10 mm
# 7 =	7/16 in.	11 mm
# 8 =	1/2 in.	12.5 mm
#10 =	5/8 in.	16 mm

(5) TIG torch nozzles are typically made from alumina ceramic. Special applications may require lava nozzles, which are less prone to breakage, but cannot withstand high temperatures and high duty cycles.

CV-WIRE MODE

Connect a wire feeder to the Vantage and set welder controls according to the instructions listed earlier in this section.

The Vantage in the "CV-WIRE" position, permits it to be used with a broad range of flux cored wire (Innershield and Outershield) electrodes and solid wires for MIG welding (gas metal arc welding). Welding can be finely tuned using the "ARC CONTROL". Turning the ARC CONTROL clockwise from -10(soft) to +10(crisp) changes the arc from soft and washed-in to crisp and narrow. It acts as an inductance/pinch control. The proper setting depends on the procedure and operator preference. Start with the knob set at 0.

For any electrodes, the procedures should be kept within the rating of the machine. For additional electrode information, See www.lincolnelectric.com or the appropriate Lincoln publication.

ARC GOUGING

For optimal performance when arc gouging, set the Vantage "WELD MODE" switch to the "CC - STICK" position, and the "ARC CONTROL" to 10.

Set the "OUTPUT" knob to adjust output current to the desired level for the gouging electrode being used according to the ratings in the following table:

* Maximum current setting is limited to the Vantage maximum of 575 Amps.

ELECTRODE DIAMETER	CURRENT RANGE (DC, electrode positive)
(1/8")	30-60 Amps
(5/32")	90-150 Amps
(3/16")	200-250 Amps
(1/4")	300-400 Amps
(5/16")	350-450 Amps
(3/8")	450-575 Amps*

PARALLELING

When paralleling machines in order to combine their outputs, all units must be operated in the CC - STICK mode only at the same output settings. To achieve this turn the WELD MODE switch to the CC - STICK position. Operation in other modes may produce erratic outputs, and large output imbalances between the units.

AUXILIARY POWER OPERATION

Start the engine and set the IDLER control switch to the desired operating mode. Full power is available regardless of the welding control settings, if no welding current is being drawn.

The auxiliary power of the Vantage consists of two 20 Amp-120VAC (5-20R) GFCI duplex receptacles and one 50 Amp-120/240 VAC (14-50R) receptacle. The 120/240VAC receptacle can be split for single phase 120 VAC operation.

The auxiliary power capacity is 12,000 watts of 60 Hz, single phase power. The auxiliary power capacity rating in watts is equivalent to volt-amperes at unity power factor. The maximum permissible current of the 240 VAC output is 50 A. The 240 VAC output can be split to provide two separate 120 VAC outputs with a maximum permissible current of 50 A per output to two separate 120 VAC branch circuits. Output voltage is within $\pm 10\%$ at all loads up to rated capacity.

NOTE: The two 120V GFCI receptacles and the two 120V circuits of the 120/240V receptacle are connected to different phases and cannot be paralleled.

The auxiliary power receptacles should only be used with three wire grounded type plugs or approved double insulated tools with two wire plugs.

The current rating of any plug used with the system must be at least equal to the current capacity of the associated receptacle.

SIMULTANEOUS WELDING AND AUXILIARY POWER LOADS

It must be noted that the above auxiliary power ratings are with no welding load. Simultaneous welding and power loads are specified in table B.4. The permissible currents shown assume that current is being drawn from either the 120 VAC or 240 VAC supply (not both at the same time).

TABLE B.4 Vantage Simultaneous Welding and Power Loads

Welding Output at NEMA Voltage (V=.04I + 20)	Permissible Power Watts (Unity Power Factor)	Permissible Auxiliary Current in Amperes	
		@ 120VAC * +/- 10%	@ 240 VAC +/- 10%
0-250A/30V	12,000	100**	50
350A/34V	8,100	68**	34
400A/36V	5,600	46	23
450A/38V	2,900	24	12
500A/40V	0	0	0

* Each duplex receptacle is limited to 20 amps.

** Not to exceed 50A per 120 VAC branch circuit when splitting the 240 VAC output.

TABLE B.5 Vantage Extension Cord Length Recommendations

Current (Amps)	Voltage (Volts)	Load (Watts)	Maximum Allowable Cord Length in ft. (m) for Conductor Size											
			14 AWG		12 AWG		10 AWG		8 AWG		6 AWG		4 AWG	
15	120	1800	30	(9)	40	(12)	75	(23)	125	(38)	175	(53)	300	(91)
15	240	3600	60	(18)	75	(23)	150	(46)	225	(69)	350	(107)	600	(183)
20	120	2400			30	(9)	50	(15)	88	(27)	138	(42)	225	(69)
20	240	4800			60	(18)	100	(30)	175	(53)	275	(84)	450	(137)
25	240	6000					90	(27)	150	(46)	225	(69)	250	(76)
30	240	7200					75	(23)	120	(37)	175	(53)	300	(91)
38	240	9000							100	(30)	150	(46)	250	(76)
50	240	12000									125	(38)	200	(61)

Conductor size is based on maximum 2.0% voltage drop.

OPTIONAL FIELD INSTALLED ACCESSORIES

K704 ACCESSORY SET - Includes 35 feet (10 m) of electrode cable and 30 feet (9 m) of work cable, headshield, work clamp and electrode holder. Cable is rated at 500 amps, 60% duty cycle.

K767-2 FOUR WHEELED STEERABLE YARD TRAILER - For in plant and yard towing.

K802N POWER PLUG KIT - Provides four 120V plugs rated at **20 amps** each and one dual voltage, full KVA plug rated at 120/240V, 50 amps. 120V plug may not be compatible with NEMA common household receptacles.

K802-R POWER PLUG KIT - Provides four 120V plugs rated **15 amps** each and one dual voltage, full KVA plug rated at 120/240V, 50 amps, 120V plug is compatible with NEMA common household receptacles.

K857 25 ft. (7.5 m) or K857-1 100 ft. (30.4 m) REMOTE CONTROL - Portable control provides same dial range as the output control on the welder from a location up to the specified length from the welder. Has convenient plug for easy connection to the welder. The Vantage 500 DEUTZ is equipped with a 6-pin connector for connecting the remote control.

K953-1 TRAILER - Two-wheeled trailer with optional fender and light package. For highway use, consult applicable federal, state, and local laws regarding possible additional requirements. There is a choice of 2 hitches, a fender & a light package. **Order:**

K953-1 Trailer

K958-1 Ball Hitch

K958-2 Lunette Eye Hitch

K959-1 Fender & Light Kit

K965-1 Cable Rack

K887-1 ETHER START KIT - Provides maximum cold weather starting assistance for frequent starting below 10 °F(-12.2 °C). Required Ether tank is not provided with kit.

K899-1 SPARK ARRESTOR KIT - Easily mounts to standard muffler.

K949-1 OIL DRAIN KIT - Includes ball valve, hose and clamp.

K1751-1 COLD WEATHER KIT - Air recirculation system maintain Deutz engine temperature in extremely cold weather conditions.

K1816-1 Full KVA Adapter Kit - Plugs into the 120/240V NEMA 14-50R receptacle on the case front (which accepts 4-prong plugs) and converts it to a NEMA 6-50R receptacle (which accepts 3-prong plugs) for connection to Lincoln Equipment with a NEMA 6-50P plug,

 **WARNING**

Pipe Thawing with an arc welder can cause fire, explosion, damage to electric wiring or to the arc welder if done improperly. The use of an arc welder for pipe thawing is not approved by the CSA, nor is it recommended or supported by Lincoln Electric.

Vantage 500 DEUTZ



SAFETY PRECAUTIONS



WARNING

- Have a qualified technician do the maintenance and troubleshooting work.
- Turn the engine off before working inside the machine.
- Remove guards only when necessary and replace them when the maintenance requiring their removal is complete.
- Always use the greatest care when working near moving parts.

Read the Safety Precautions in front of this manual and the engine instruction manual before working on this machine.

Keep all equipment safety guards, covers and devices in position and in good repair. Keep hands, hair, clothing and tools away from V-belts, gears, fans and all other moving parts when starting, operating or repairing the equipment.

ROUTINE AND PERIODIC MAINTENANCE

DAILY

- Check the crankcase oil level .
- Refill the fuel tank to minimize moisture condensation in the tank.
- Open the water drain valve located on the bottom of the water separator element 1 or 2 turns and allow to drain into a container suitable for diesel fuel for 2 to 3 seconds. Repeat the above drainage procedure until diesel fuel is detected in the co

WEEKLY

Blow out the machine with low pressure air periodically. In particularly dirty locations, this may be required once a week.

ENGINE MAINTENANCE

Refer to the "Periodic Checks" section of the Engine Operator's Manual for the recommended maintenance schedule of the following:

- Engine Oil and Filter
- Air Cleaner
- Fuel Filter - and Delivery System
- Cooling Blower Belt
- Battery
- Cooling System

Refer to Table D.1 at the end of this section for various engine maintenance components.

AIR FILTER



CAUTION

EXCESSIVE AIR FILTER RESTRICTION WILL RESULT IN REDUCED ENGINE LIFE.

The air filter element is a dry cartridge type. It can be cleaned and reused; however, damaged elements should not be reused. Stop engine after 100 hours of running time and clean filter element , replace the filter if necessary. Service air cleaner regularly according to Engine Operator's Manual.

1. Locate the air filter canister located behind the engine door on the top of the engine.
2. Remove air filter element.
3. Remove loose dirt from element with compressed air or water hose directed from inside out.

Compressed Air: 100 psi maximum with nozzles at least one inch away from element.

Water Hose: 40 psi maximum without nozzle.

4. Soak element in a mild detergent solution for 15 minutes. Do not soak more than 24 hours. Swish element around in the solution to help remove dirt.
5. Rinse elements from inside out with a gentle stream of water (less than 40 psi) to remove all suds and dirt.
6. Dry element before reuse with warm air at less than 160°F (71°C). Do not use a light bulb to dry the element.

7. Inspect for holes and tears by looking through the element toward a bright light. Check for damaged gaskets or dented metal parts. Do not reuse damaged elements. Protect element from dust and damage during drying and storage.
8. Reinstall air filter element.

After six cleanings replace air filter. A cleaned filter will have approximately 70% of the life of a new filter element. A restricted filter element may not appear excessively dirty.

FUEL FILTERS

WARNING

When working on the fuel system



- Keep naked lights away, do not smoke !
- Do not spill fuel !

The Vantage is equipped with a **Fuel Pre-Filter/Water Separator Assembly** located before the lift pump and a **Secondary Fuel Filter** located after the lift pump and before the fuel injectors. The Fuel Pre-Filter/Water Separator is mounted to the engine block just below the lift pump. The Secondary Fuel Filter is mounted directly to the engine just above the oil filter.

FUEL PRE-FILTER/WATER SEPARATOR ASSEMBLY

The pre-filter is a 150 micron screen designed to protect against gross fuel contamination of the water separator element and the Secondary Fuel Filter. If the pre-filter becomes plugged it may be removed, inspected, cleaned and reinstalled. In general this only needs to be done with each water separator element change (about every 1,000 hrs.) However if at any time excessive fuel contamination is suspected or a sudden fall-off in engine performance is detected the pre-filter screen should be inspected and cleaned. Follow the following procedure:

1. Close the fuel shutoff valve (Lever should be perpendicular to the hose) located on the side of the Fuel Pre-Filter/Water Separator Assembly.
2. Unscrew the cap ring located on the top of the filter header and remove the plastic center cap and O-ring.
3. Remove the large white volume plug located directly under the center cap in the upper cavity of the filter header. Use a small screwdriver (or similar device) to lift the plug part way out of the cavity to assist with its removal.

Be careful not to damage the pre-filter screen with the tool used to remove the plug.

4. Using a pair of pliers, gently tug on the pull tabs of the pre-filter screen in an alternating pattern to gradually remove the pre-filter screen.
5. Brush off any debris and rinse in diesel fuel.
6. Re-install the pre-filter screen into the upper cavity of the filter header making sure the four pull tabs are pointing up. Putting your fingers on the pull tabs, push down evenly until the lower body of the pre-filter screen contacts the floor of the upper cavity.

7. Re-insert the large white volume plug into the upper cavity.
8. Place the O-ring onto the angled seal surface of the filter header and re-install the plastic cap. Make sure its flange rests on the O-ring.
9. Screw on the cap ring and tighten hand tight.
10. Remember to open the fuel shutoff valve (Lever in line with the hose) before starting the engine.

WATER SEPARATOR ELEMENT

The water separator element is a two stage filter with a special filtration/water separating media, and an expanded water reservoir providing maximum protection against water in the fuel. The recommended change interval for the water separator element is 1,000 hours. The procedure for changing the element is as follows:

1. Close the fuel shutoff valve (Lever should be perpendicular to the hose) located on the side of the Fuel Pre-Filter/Water Separator Assembly.
2. Rotate the quick change ring (located just below filter header) clockwise approximately 1/2 turn and slide it down and off of the element.
3. Grasp the element and pull down with a slight rocking motion to remove the element from the grommet post on the bottom of the filter header.
4. Slide the new element onto the grommet post on the bottom of the filter header until the element no longer easily moves up into the filter header. Now rotate the element (may take almost 1 full turn) with a slight upward pressure until the element begins to further engage the header. With the proper orientation now established apply additional pressure to seat the element in the filter header. You should feel the element "pop" into place when properly seated.

Note: The element will only go on one way. Never use excessive force when mounting the element to the header.

5. Slide the quick change ring up over the element and rotate counter clockwise until an audible click or pop is heard. If you do not hear the click you have not rotated the ring far enough and the element is not in the locked position. Another indication that the ring is in the locked position is that one set (it doesn't matter which one) of arrows located on the outside of the ring should be located directly under the air vent valve.
6. Open the fuel shutoff valve (lever in line with the hose).
7. Open the air vent valve on the front of the filter header until fuel emerges free of air bubbles and then close the air vent valve.

Note : Consult your engine operation manual for information on air bleeding the entire fuel system.

SECONDARY FUEL FILTER

The Secondary Fuel Filter is a spin on cartridge type mount directly to the engine. Consult your engine operation manual for complete information on service intervals and element changing procedures.

COOLING SYSTEM

The cooling system of the Deutz engine needs to be checked and cleaned periodically. Consult the engine owners manual for the proper frequency and procedure.

COOLING BLOWER BELT

The following procedure should be followed to replace the cooling blower belt:

1. Allow the machine to cool.
2. Unfasten and slide the battery holder out from the welder.
3. Disconnect the negative battery cable.
4. Remove engine case side.
5. Loosen air cleaner hose clamp and detach hose.
6. Remove the engine end panel with air box and air cleaner attached for access to the engine.
7. Loosen the alternator mounting bolts and rotate the alternator towards the engine.
8. Remove the old cooling blower belt and install a new one.
9. Adjust the cold belt tension to 63-73 lbs. midway between any two pulleys.
10. Reinstall the air cleaner hose, engine case side and end panel. Reattach the negative battery cable. Slide in and refasten the battery holder.
11. Check the cooling blower belt tension after 100 hours of operation. (Follow steps 1,2,3,4,5,6,9 & 10)

BATTERY HANDLING

GASES FROM BATTERY can explode.

- Keep sparks, flame and cigarettes away from battery.



To prevent EXPLOSION when:

- **INSTALLING A NEW BATTERY** - disconnect negative cable from old battery first and connect to new battery last.

- **CONNECTING A BATTERY CHARGER** - Remove battery from welder by disconnecting negative cable first, then positive cable and battery clamp. When reinstalling, connect negative cable last. Keep well ventilated.



- **USING A BOOSTER** - connect positive lead to battery first then connect negative lead to engine foot.

BATTERY ACID CAN BURN EYES AND SKIN.

- Wear gloves and eye protection and be careful when working near battery. Follow instructions printed on battery.



PREVENTING ELECTRICAL DAMAGE

1. When replacing, jumping, or otherwise connecting the battery to the battery cables, the proper polarity must be observed. Failure to observe the proper polarity could result in damage to the charging circuit. The positive (+) battery cable has a red terminal cover.
2. If the battery requires charging from an external charger, disconnect the negative battery cable first and then the positive battery cable before attaching the charger leads. Failure to do so can result in damage to the internal charger components. When reconnecting the cables, connect the positive cable first and the negative cable last.

PREVENTING BATTERY DISCHARGE

Turn off the RUN/STOP to stop when engine is not running.

PREVENTING BATTERY BUCKLING

Tighten nuts on battery clamp until snug.

CHARGING THE BATTERY

When you charge, jump, replace, or otherwise connect battery cables to the battery, be sure the polarity is correct. Improper polarity can damage the charging circuit. The Vantage positive (+) battery terminal has a red terminal cover.

If you need to charge the battery with an external charger, disconnect the negative cable first, then the positive cable before you attach the charger leads. After the battery is charged, reconnect the positive battery cable first and the negative cable last. Failure to do so can result in damage to the internal charger components.

Follow the instructions of the battery charger manufacturer for proper charger settings and charging time.

NAMEPLATES / WARNING DECALS MAINTENANCE

Whenever routine maintenance is performed on this machine - or at least yearly - inspect all nameplates and labels for legibility. Replace those which are no longer clear. Refer to the parts list for the replacement item number.

WELDER / GENERATOR MAINTENANCE**STORAGE**

Store the Vantage in clean, dry protected areas.

CLEANING

Blow out the generator and controls periodically with low pressure air. Do this at least once a week in particularly dirty areas.

BRUSH REMOVAL AND REPLACEMENT

It is normal for the brushes and slip rings to wear and darken slightly. Inspect the brushes when a generator overhaul is necessary.



Do not attempt to polish slip rings while the engine is running.

Table D.1 Engine Maintenance Components

ITEM	MAKE	PART NUMBER
Air Cleaner Element	Donaldson AC	P181052 A302C
Cooling Blower Belt	Lincoln Gates	T13536-3 7585
Oil Filter Element	Deutz Purolator Napa Fram	1174418 PER2168 1820 PH3776
Fuel Filter Element	Deutz Purolator Napa Fram	1174423 PC42 3358 P4102
Water Separator Element	Lincoln Stanadyne	M16890-C 31572
Fuel Pre-Filter Screen	Lincoln Stanadyne	M16890-B 29575
Battery		BCI Group 34

HOW TO USE TROUBLESHOOTING GUIDE



WARNING

Service and Repair should only be performed by Lincoln Electric Factory Trained Personnel. Unauthorized repairs performed on this equipment may result in danger to the technician and machine operator and will invalidate your factory warranty. For your safety and to avoid Electrical Shock, please observe all safety notes and precautions detailed throughout this manual.

This Troubleshooting Guide is provided to help you locate and repair possible machine malfunctions. Simply follow the three-step procedure listed below.

Step 1. LOCATE PROBLEM (SYMPTOM).

Look under the column labeled "PROBLEM (SYMPTOMS)". This column describes possible symptoms that the machine may exhibit. Find the listing that best describes the symptom that the machine is exhibiting.

Step 2. POSSIBLE CAUSE.

The second column labeled "POSSIBLE CAUSE" lists the obvious external possibilities that may contribute to the machine symptom.

Step 3. RECOMMENDED COURSE OF ACTION

This column provides a course of action for the Possible Cause, generally it states to contact your local Lincoln Authorized Field Service Facility.

If you do not understand or are unable to perform the Recommended Course of Action safely, contact your local Lincoln Authorized Field Service Facility.



CAUTION

If for any reason you do not understand the test procedures or are unable to perform the tests/repairs safely, contact your Local **Lincoln Authorized Field Service Facility** for technical troubleshooting assistance before you proceed.

Vantage 500 DEUTZ



Observe all Safety Guidelines detailed throughout this manual

PROBLEMS (SYMPTOMS)	POSSIBLE AREAS OF MISADJUSTMENT(S)	RECOMMENDED COURSE OF ACTION
ENGINE PROBLEMS		
Major Physical or Electrical Damage is Evident.	1. Contact your Local Lincoln Authorized Field Service Facility.	If all recommended possible areas of misadjustment have been checked and the problem persists, Contact your local Lincoln Authorized Field Service Facility.
Engine will not crank	<ol style="list-style-type: none"> 1. Battery low. 2. Loose battery cable connections which may need Inspected, cleaned or tighten. 3. Faulty wiring in engine starting circuit. 4. Faulty engine starter. Contact authorized local Engine Service Shop. 	
Engine will crank but not start.	<ol style="list-style-type: none"> 1. Out of fuel. 2. Fuel shut off valve is in the off position make sure the valve lever is in a vertical direction. 3. Engine shut down solenoid not pulling in. 4. On/Off switch on for more than 30 sec. before starting, the On/Off switch will need to be switch off and turned back on. 5. Fuel Filters dirty/clogged, main filter element and/or Inline Fuel Filter may need to be replaced. 6. High oil temperature or low oil pressure. (engine protection light lit) 	
Engine shuts down shortly after starting.	<ol style="list-style-type: none"> 1. Low oil pressure (engine protection light lit). Check oil level (Consult engine service dealer). 2. High oil temperature. (engine protection light lit). 3. Faulty oil pressure switch. 4. Faulty oil temperature switch. Contact authorized local Engine Service Shop. 5. Low output of battery charging alternator (battery charging light lit). 	
Engine shuts down while under a load.	1. High oil temperature. .	
Engine runs rough.	<ol style="list-style-type: none"> 1. Dirty fuel or air filters may need cleaned/replaced. 2. Water in fuel. 	
Engine will not shut off	1. Fuel Shutdown solenoid not functioning properly / linkage binding.	



CAUTION

⁹If for any reason you do not understand the test procedures or are unable to perform the tests/repairs safely, contact your **Local Lincoln Authorized Field Service Facility** for technical troubleshooting assistance before you proceed.

Vantage 500 DEUTZ



PROBLEMS (SYMPTOMS)	POSSIBLE AREAS OF MISADJUSTMENT(S)	RECOMMENDED COURSE OF ACTION
FUNCTION PROBLEMS		
Battery does not stay charged.	<ol style="list-style-type: none"> 1. Faulty battery . 2. Faulty engine alternator. 3. Loose or broken lead in charging circuit. 4. Loose fan belt may need tightening. 	<p>If all recommended possible areas of misadjustment have been checked and the problem persists, Contact your local Lincoln Authorized Field Service Facility.</p>
No welding output or auxiliary output.	<ol style="list-style-type: none"> 1. Broken lead in rotor circuit. 2. Faulty field diode module. 3. Faulty Weld Control P.C. Board. 4. Faulty rotor. 	
Welder has some/ no output and no control. Auxiliary output OK	<ol style="list-style-type: none"> 1. Faulty remote kit. 2. Faulty output control potentiometer. 3. Faulty output control wiring. 4. Faulty Weld Control PCB, Pull Coil/Battery PCB or Chopper PCB. 	
No welding output. Auxiliary output OK.	<ol style="list-style-type: none"> 1. WELDING TERMINALS switch in wrong position, be sure to place switch in WELDING TERMINALS ALWAYS ON position. 2. Faulty Weld Control PCB, Pull Coil/Battery PCB or Chopper PCB. 	
No auxiliary power.	<ol style="list-style-type: none"> 1. Open breakers. 2. Faulty receptacle. 3. Faulty auxiliary circuit wiring. 4. GFCI tripped. 	



CAUTION

If for any reason you do not understand the test procedures or are unable to perform the tests/repairs safely, contact your **Local Lincoln Authorized Field Service Facility** for technical troubleshooting assistance before you proceed.

Vantage 500 DEUTZ



VANTAGE 500 WIRING DIAGRAM (DEUTZ)

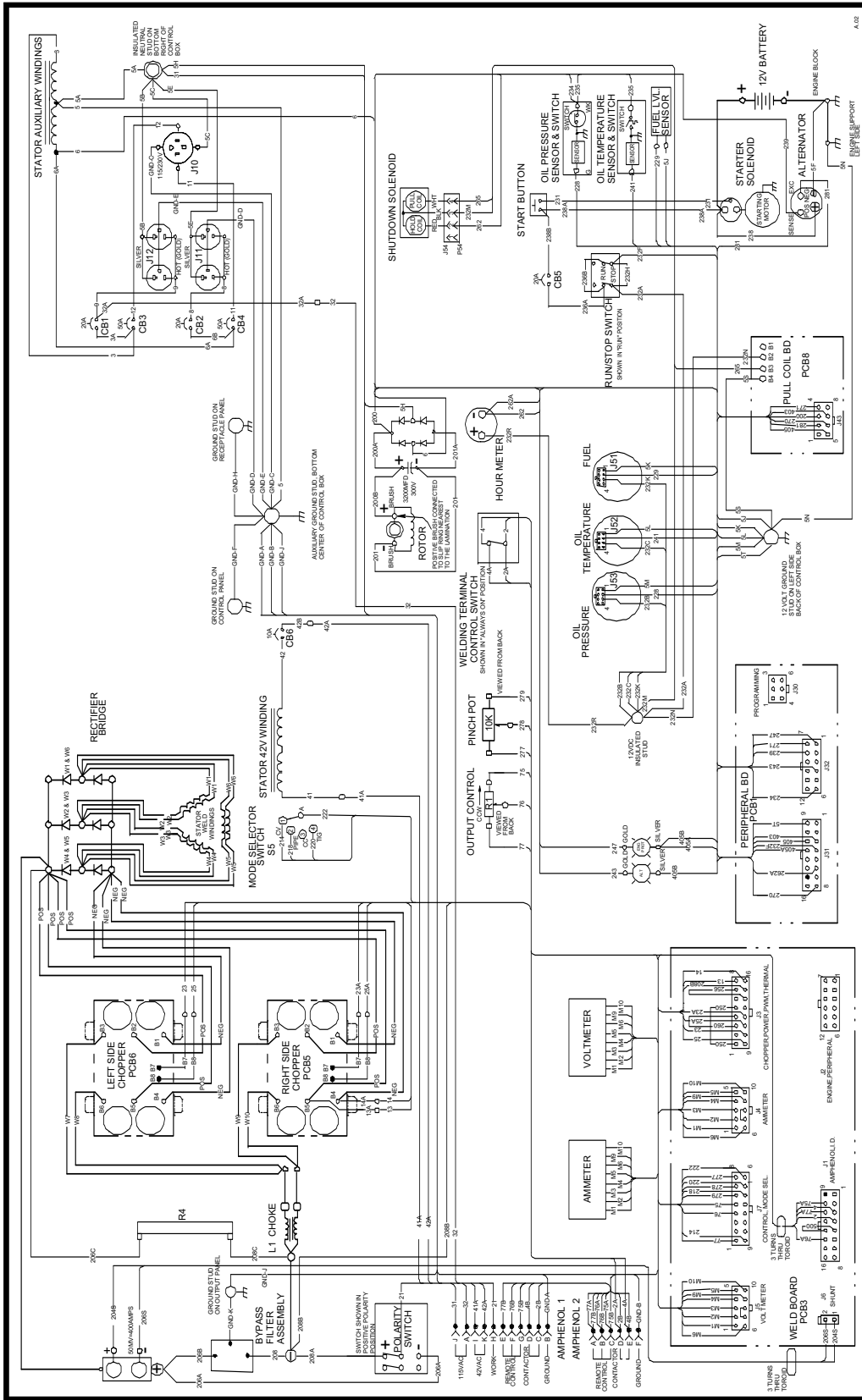

G4342

NOTE: This diagram is for reference only. It may not be accurate for all machines covered by this manual. The specific diagram for your particular machine is pasted inside the machine on one of the enclosure panels.

CONNECTION DIAGRAM:

ENGINE WELDERS / K691-10 / K488 / K487 SPOOL GUN CONNECTION DIAGRAM

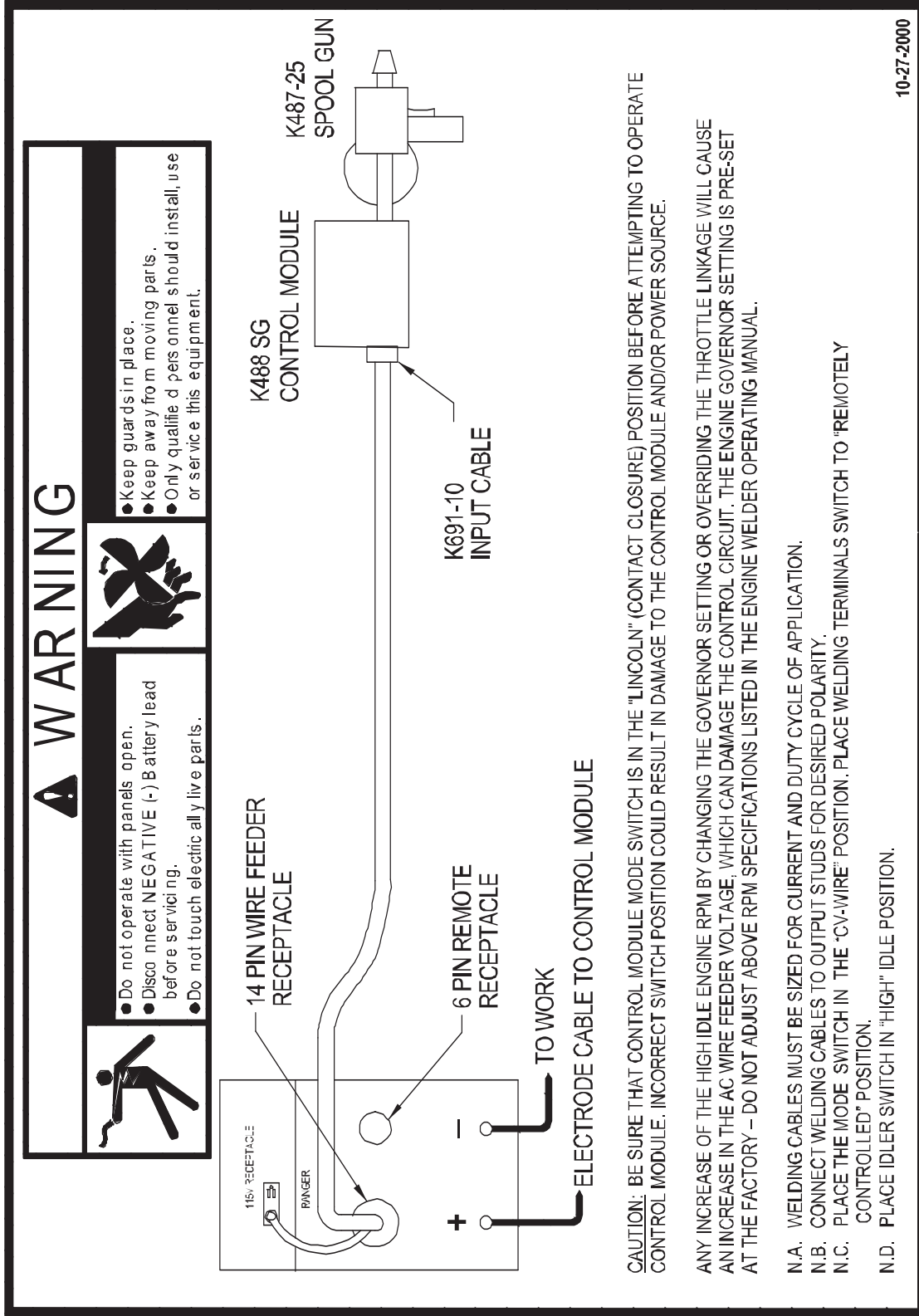

CONNECTION DIAGRAM:

COMMANDER / K867 / K775 / LN-7 CONNECTION DIAGRAM

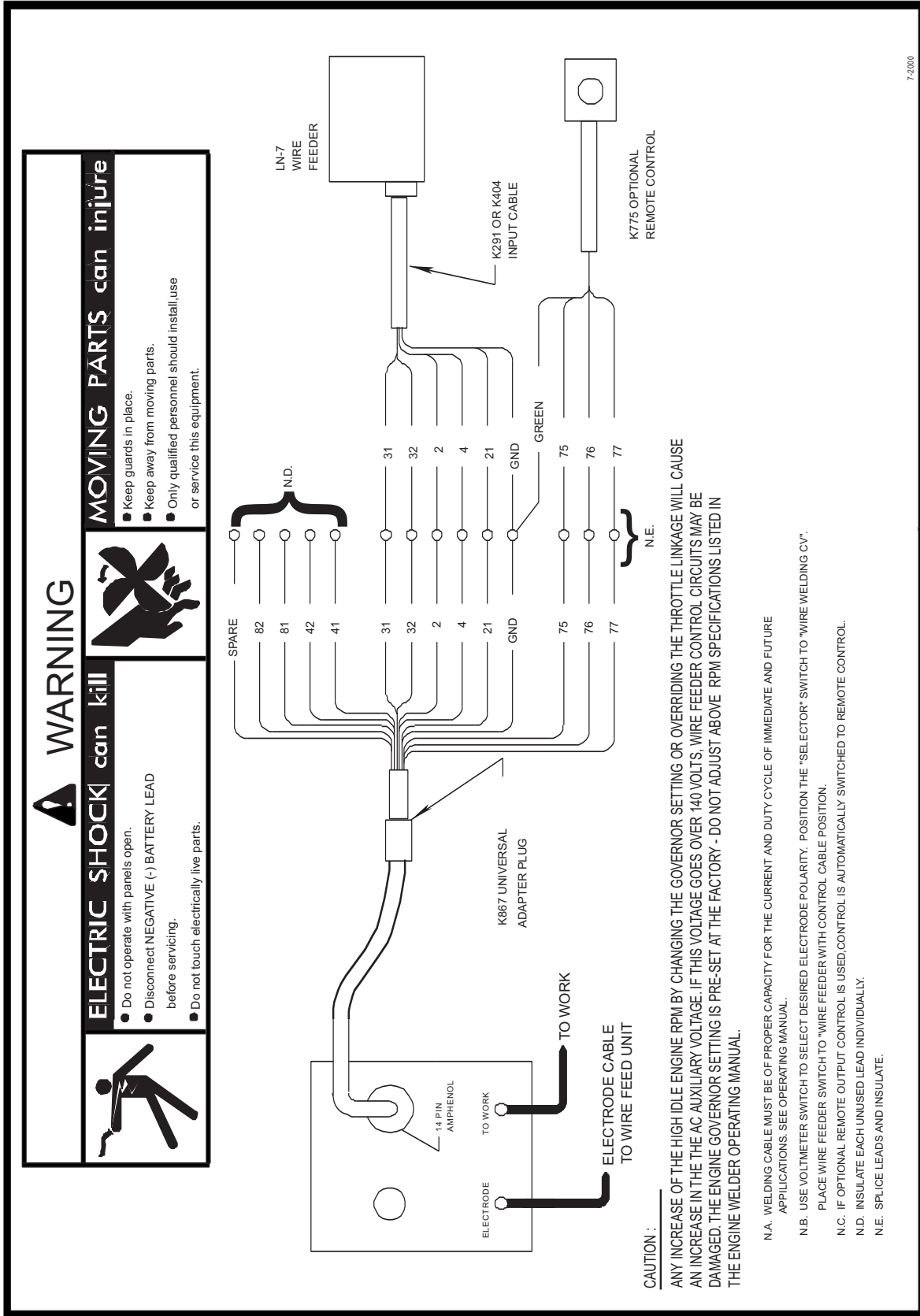

CONNECTION DIAGRAM

ENGINE WELDERS /LN-7 CONNECTION DIAGRAM

		
<p>WARNING</p>	<ul style="list-style-type: none"> ● Do not operate with panels open. ● Disconnect NEGATIVE (-) Battery lead before servicing. ● Do not touch electrically live parts. 	<ul style="list-style-type: none"> ● Keep guards in place. ● Keep away from moving parts. ● Only qualified personnel should install, use or service this equipment.

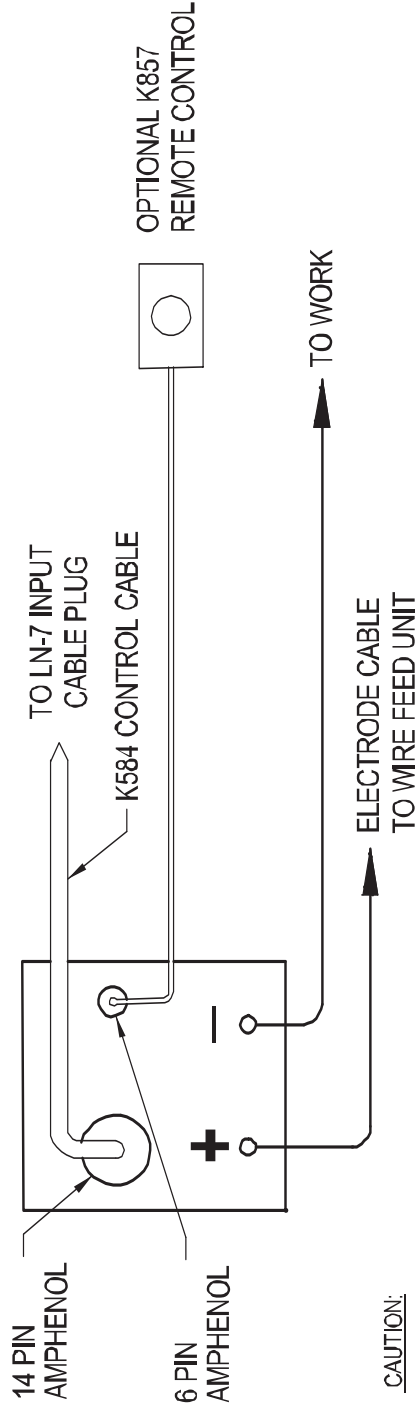

CAUTION:

ANY INCREASE OF THE HIGH IDLE ENGINE RPM BY CHANGING THE GOVERNOR SETTING OR OVERRIDING THE THROTTLE LINKAGE WILL CAUSE AN INCREASE IN THE AC WIRE FEEDER VOLTAGE, WHICH CAN DAMAGE THE CONTROL CIRCUIT. THE ENGINE GOVERNOR SETTING IS PRE-SET AT THE FACTORY – DO NOT ADJUST ABOVE RPM SPECIFICATIONS LISTED IN THE ENGINE WELDER OPERATING MANUAL.

N.A. WELDING CABLES MUST BE OF PROPER CAPACITY FOR THE CURRENT AND DUTY CYCLE OF IMMEDIATE AND FUTURE APPLICATIONS. SEE OPERATING MANUAL.

N.B. CONNECT WELDING CABLES TO OUTPUT STUDS FOR DESIRED POLARITY. POSITION THE WIRE FEEDER VOLT/METER SWITCH TO MATCH THE POLARITY OF THE ELECTRODE CABLE.

N.C. PLACE THE MODE SWITCH IN THE "CV-WIRE" POSITION.

N.D. PLACE IDLER SWITCH IN "HIGH" POSITION.

10-27-2000

S24787-4

CONNECTION DIAGRAM

ENGINE WELDERS TO K867 CONTROL CABLE ADAPTER CONNECTION DIAGRAM

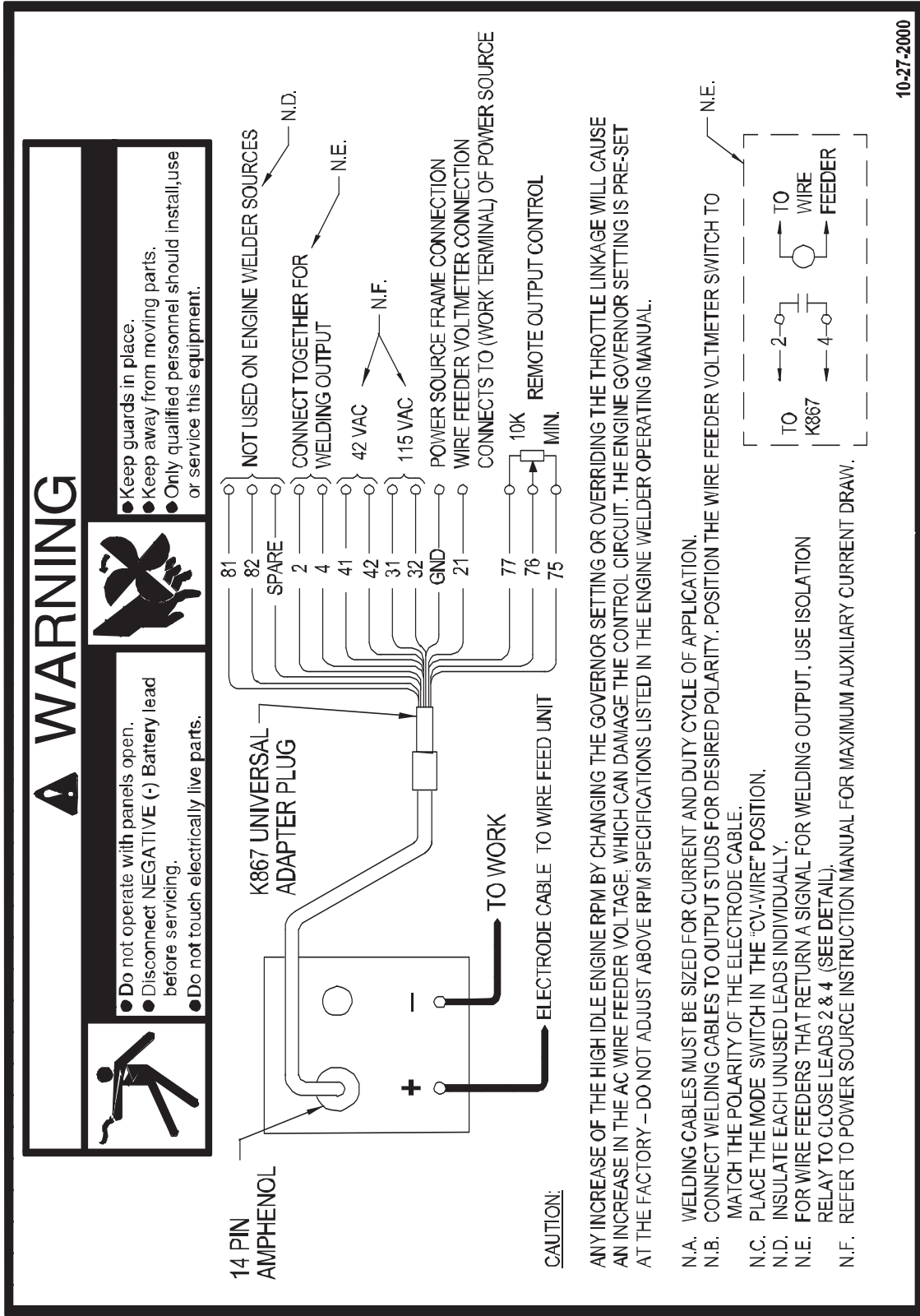

CONNECTION DIAGRAM

COMMANDER / K867 / LN-8 CONNECTION DIAGRAM

WARNING

ELECTRIC SHOCK can kill

- Do not operate with panels open.
- Disconnect NEGATIVE (-) BATTERY LEAD before servicing.
- Do not touch electrically live parts.

MOVING PARTS can injure

- Keep guards in place.
- Keep away from moving parts.
- Only qualified personnel should install, use or service this equipment.

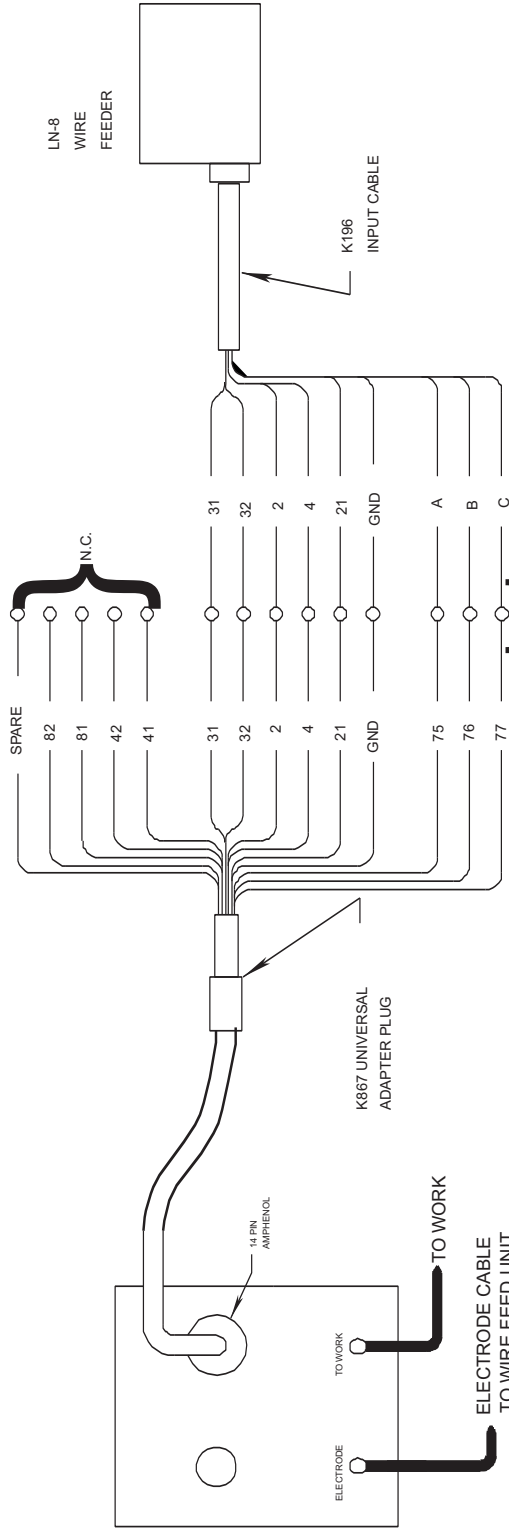

CAUTION :

ANY INCREASE OF THE HIGH IDLE ENGINE RPM BY CHANGING THE GOVERNOR SETTING OR OVERRIDING THE THROTTLE LINKAGE WILL CAUSE AN INCREASE IN THE AC AUXILIARY VOLTAGE. IF THIS VOLTAGE GOES OVER 140 VOLTS, WIRE FEEDER CONTROL CIRCUITS MAY BE DAMAGED. THE ENGINE GOVERNOR SETTING IS PRE-SET AT THE FACTORY - DO NOT ADJUST ABOVE RPM SPECIFICATIONS LISTED IN THE ENGINE WELDER OPERATING MANUAL.

N.A. WELDING CABLE MUST BE OF PROPER CAPACITY FOR THE CURRENT AND DUTY CYCLE OF IMMEDIATE AND FUTURE APPLICATIONS. SEE OPERATING MANUAL.

N.B. USE VOLTMETER SWITCH TO SELECT DESIRED ELECTRODE POLARITY. POSITION THE SELECTOR SWITCH TO "WIRE WELDING CV".

N.C. INSULATE EACH UNUSED LEAD INDIVIDUALLY.
N.D. SPLICE LEADS AND INSULATE.

7-2000

S23989

CONNECTION DIAGRAM

CONNECTION DIAGRAM: ENGINE WELDERS COMPATIBLE WITH LN-23P WITH K350-1 ADAPTER KIT

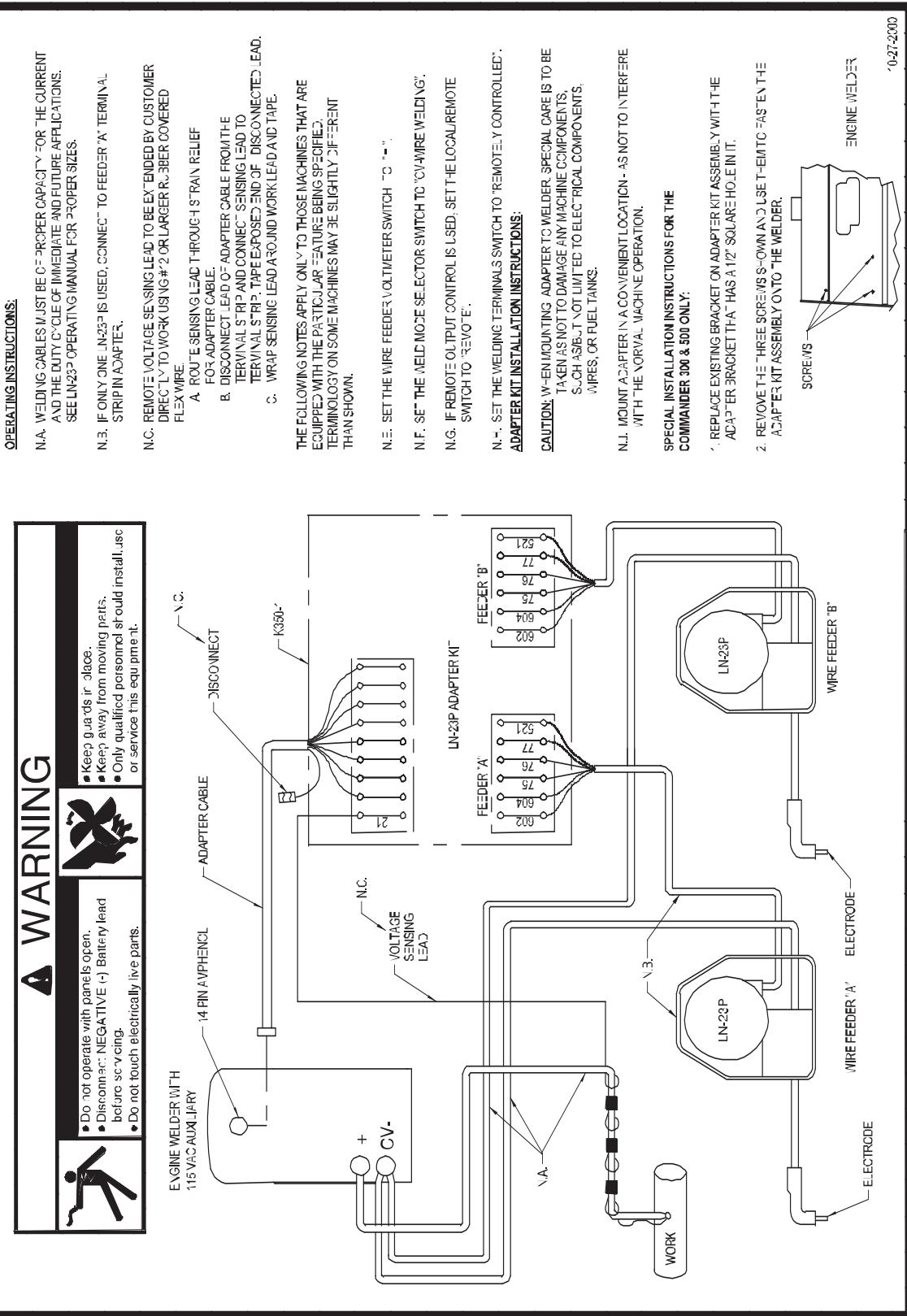

WARNING

- Do not operate with panels open.
 - Disconnect NEGATIVE (-) Battery lead before servicing.
 - Do not touch electrically live parts.
- Keep guards in place.
 - Keep away from moving parts.
 - Only qualified personnel should install, use or service this equipment.

OPERATING INSTRUCTIONS:

N.A. WELDING CABLES MUST BE CORRECT CAPACITY FOR THE CURRENT AND THE DUTY CYCLE OF IMMEDIATE AND FUTURE APPLICATIONS. SEE LN-23P OPERATING MANUAL FOR PROPER SIZES.

N.B. IF ONLY ONE LN-23P IS USED, CONNECT TO FEEDER 'A' TERMINAL STRIP IN ADAPTER.

N.C. REMOVE VOLTAGE SENSING LEAD TO BE EXTENDED BY CUSTOMER DIRECTLY TO WORK USING #2 OR LARGER RUBBER COVERED FLEX WIRE.

- A. ROUTE SENSING LEAD THROUGH STRAIN RELIEF FOR ADAPTER CABLE.
- B. DISCONNECT LEAD OF ADAPTER CABLE FROM THE TERMINAL STRIP AND CONNECT SENSING LEAD TO TERMINAL STRIP TAPE EXPOSED END OF DISCONNECTED LEAD.
- C. WRAP SENSING LEAD AROUND WORK LEAD AND TAPE.

THE FOLLOWING NOTES APPLY ONLY TO THOSE MACHINES THAT ARE EQUIPPED WITH THE PARTICULAR FEATURE BEING SPECIFIED. TERMINOLOGY ON SOME MACHINES MAY BE SLIGHTLY DIFFERENT THAN SHOWN.

N.E. SET THE WIRE FEEDER VOLT/METER SWITCH TO "A".

N.F. SET THE WELD MODE SELECTOR SWITCH TO "CV WIRE WELDING".

N.G. IF REMOTE OUTPUT CONTROL IS USED, SET THE LOCAL REMOTE SWITCH TO "REMOTE".

N.H. SET THE WELDING TERMINALS SWITCH TO "REMOTELY CONTROLLED".

ADAPTER KIT INSTALLATION INSTRUCTIONS:

CAUTION: WHEN MOUNTING ADAPTER TO WELDER, SPECIAL CARE IS TO BE TAKEN AS NOT TO DAMAGE ANY MACHINE COMPONENTS, SUCH AS BUSHING, NOT LIMITED TO ELECTRICAL COMPONENTS, WIRES, OR FUEL TANKS.

N.I. MOUNT ADAPTER IN A CONVENIENT LOCATION - AS NOT TO INTERFERE WITH THE NORMAL MACHINE OPERATION.

SPECIAL INSTALLATION INSTRUCTIONS FOR THE COMMANDER 300 & 600 ONLY:

1. REPLACE EXISTING BRACKET ON ADAPTER KIT ASSEMBLY WITH THE ADAPTER BRACKET THAT HAS A 1/2" SQUARE HOLE IN IT.
2. REMOVE THE THREE SCREWS OWN AND USE THEM TO FASTEN THE ADAPTER KIT ASSEMBLY ONTO THE WELDER.

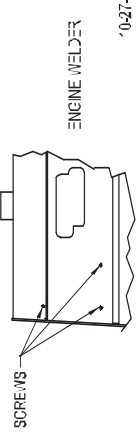

10-27-2000

M17323-P

Vantage 500 DEUTZ



CONNECTION DIAGRAM

**ENGINE WELDERS /LN-25 ACROSS THE ARC CONNECTION DIAGRAM
WITH OPTIONAL K857 REMOTE CONTROL**

	WARNING
	<ul style="list-style-type: none"> • Do not operate with panels open. • Disconnect NEGATIVE (-) Battery lead before servicing. • Do not touch electrically live parts.
	<ul style="list-style-type: none"> • Keep guards in place. • Keep away from moving parts. • Only qualified personnel should install, use or service this equipment.

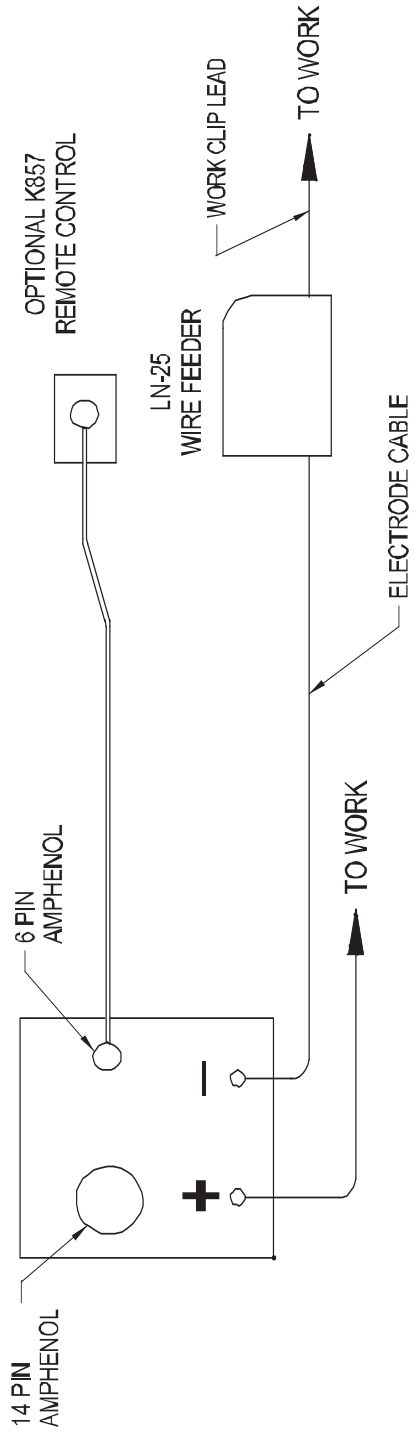

- N.A. WELDING CABLES MUST BE OF PROPER CAPACITY FOR THE CURRENT AND DUTY CYCLE OF IMMEDIATE AND FUTURE APPLICATIONS. SEE OPERATING MANUAL.
- N.B. CONNECT WELDING CABLES TO OUTPUT STUDS FOR DESIRED POLARITY. POSITION THE WIRE FEEDER VOLT-METER SWITCH TO MATCH THE POLARITY OF THE ELECTRODE CABLE.
- N.C. PLACE THE MODE SWITCH IN THE "CV-WIRE" POSITION.
- N.D. PLACE THE WELDING TERMINALS SWITCH IN THE "WELD TERMINALS ON" POSITION.
- N.E. PLACE IDLER SWITCH IN "AUTO" OR "HIGH" IDLE POSITION AS DESIRED.

10-27-2000

S24787-1

CONNECTION DIAGRAM

ENGINE WELDERS /LN-8 CONNECTION DIAGRAM

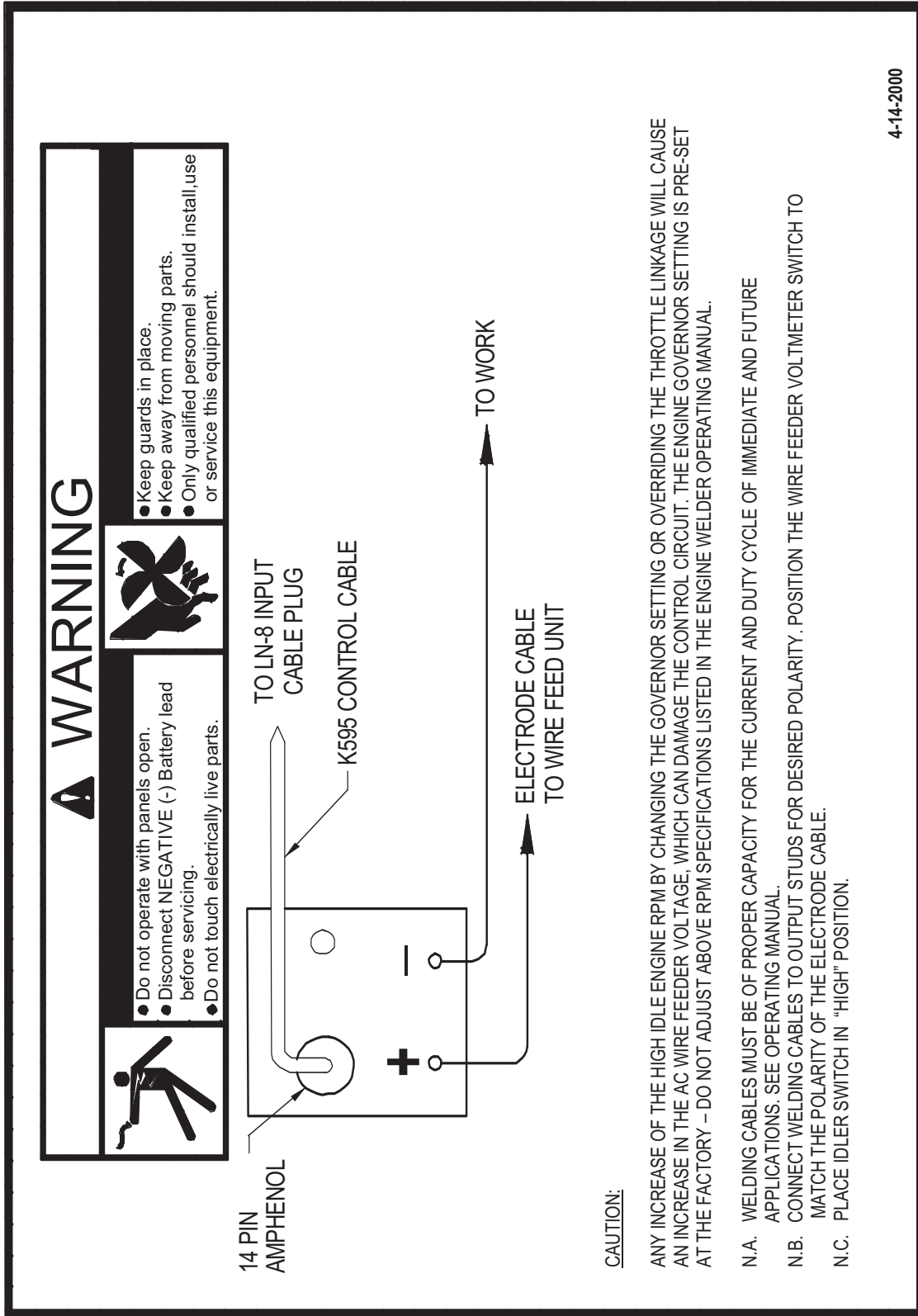

CONNECTION DIAGRAM

**ENGINE WELDERS /LN-25 WITH K624-1 42 VOLT REMOTE OUTPUT
CONTROL MODULE CONNECTION DIAGRAM**

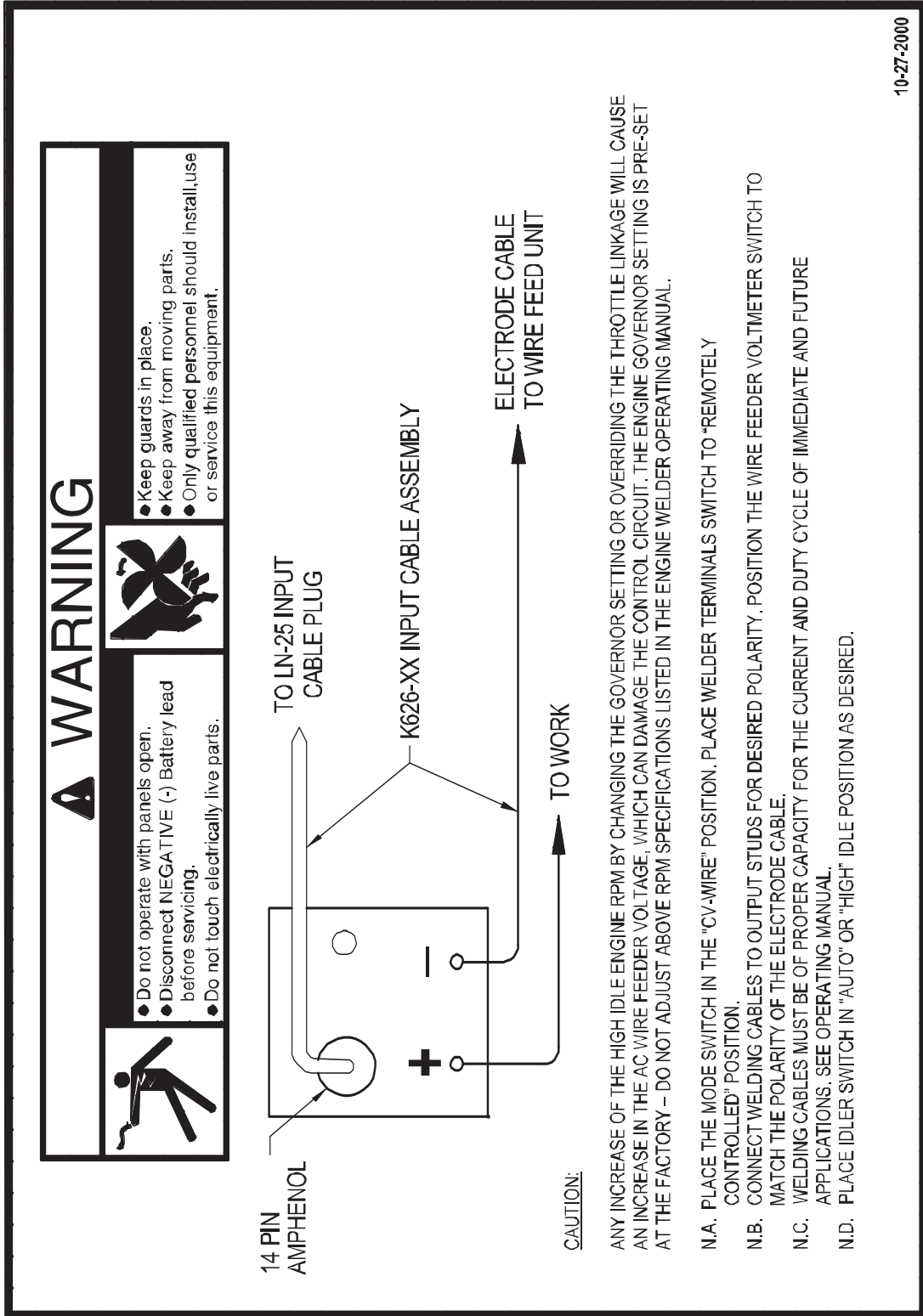

CONNECTION DIAGRAM

**ENGINE WELDERS /LN-25 ACROSS THE ARC CONNECTION DIAGRAM
WITH OPTIONAL K444-1 REMOTE CONTROL**

	WARNING	
<ul style="list-style-type: none"> • Do not operate with panels open. • Disconnect NEGATIVE (-) Battery lead before servicing. • Do not touch electrically live parts. 		<ul style="list-style-type: none"> • Keep guards in place. • Keep away from moving parts. • Only qualified personnel should install, use or service this equipment.

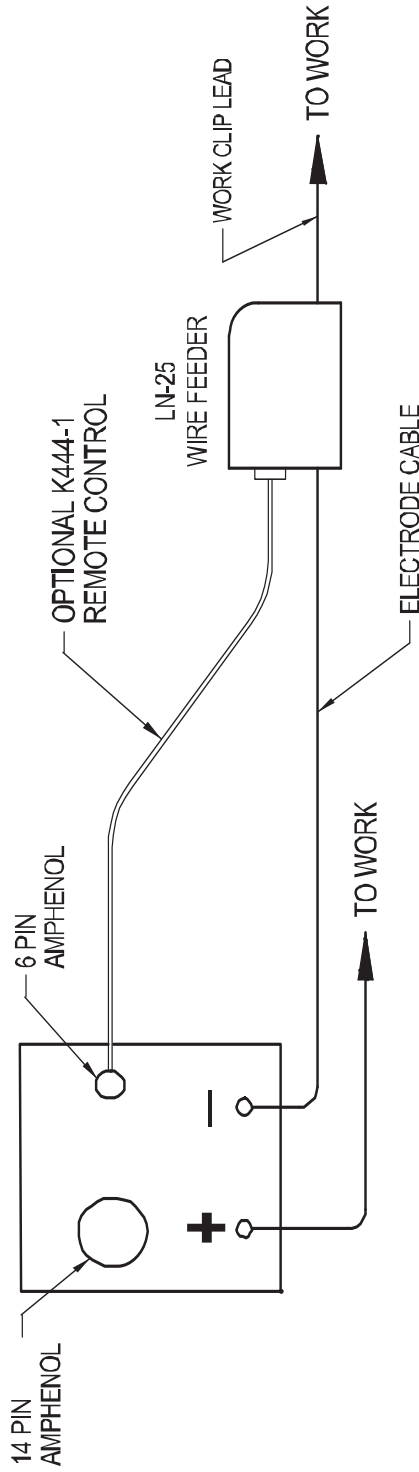

- N.A. WELDING CABLES MUST BE OF PROPER CAPACITY FOR THE CURRENT AND DUTY CYCLE OF IMMEDIATE AND FUTURE APPLICATIONS. SEE OPERATING MANUAL.
- N.B. CONNECT WELDING CABLES TO OUTPUT STUDS FOR DESIRED POLARITY. POSITION THE WIRE FEEDER VOLTMETER SWITCH TO MATCH THE POLARITY OF THE ELECTRODE CABLE.
- N.C. PLACE THE MODE SWITCH IN THE "CV-WIRE" POSITION.
- N.D. PLACE THE WELDING TERMINALS SWITCH IN THE "WELD TERMINALS ON" POSITION.
- N.E. PLACE IDLER SWITCH IN "AUTO" OR "HIGH" IDLE POSITION AS DESIRED.

10-27-2000

S24787-2

CONNECTION DIAGRAM

ENGINE WELDERS / K930 TIG MODULE / CONNECTION DIAGRAM

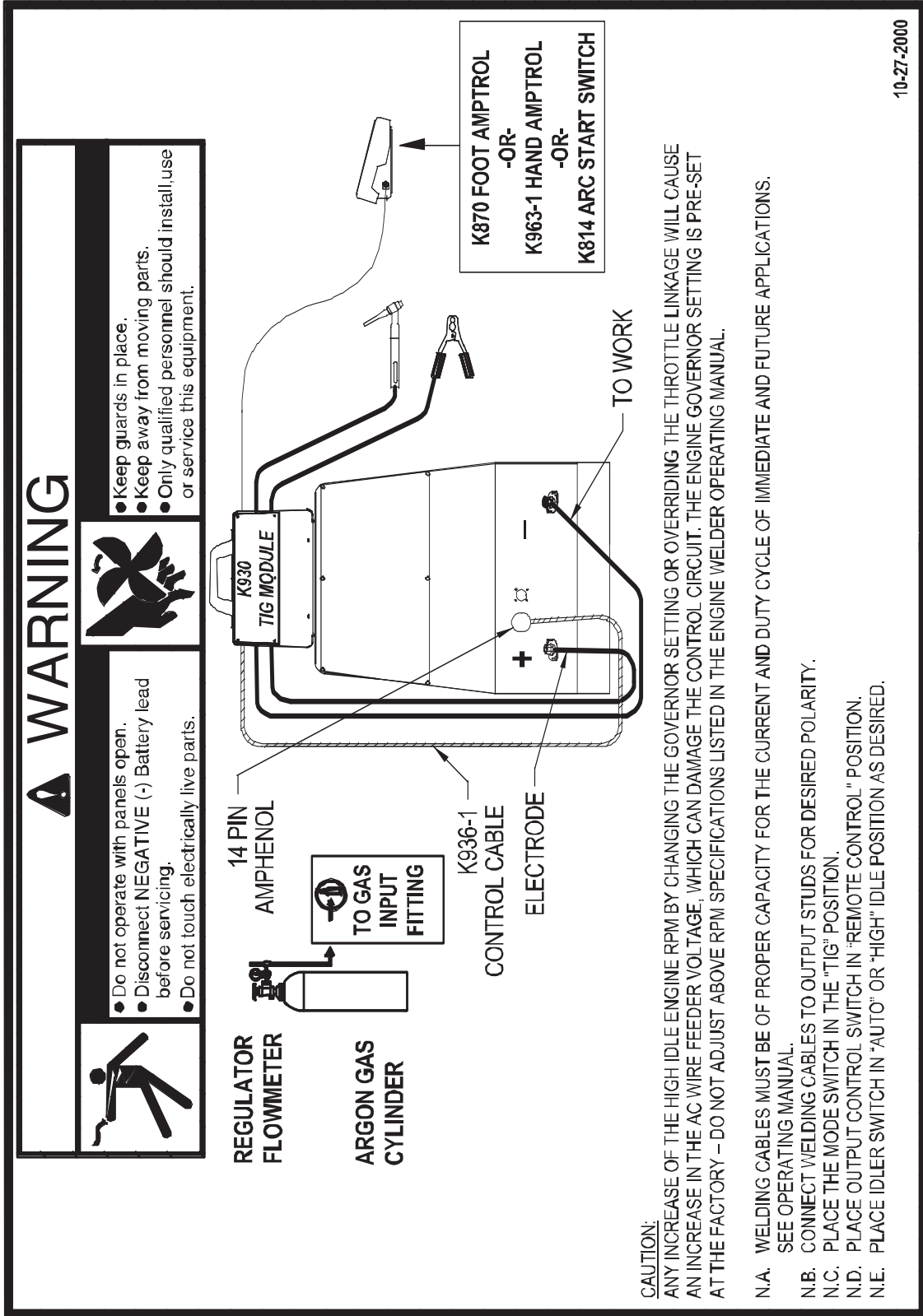

CONNECTION DIAGRAM

ENGINE WELDERS /LN-742 CONNECTION DIAGRAM

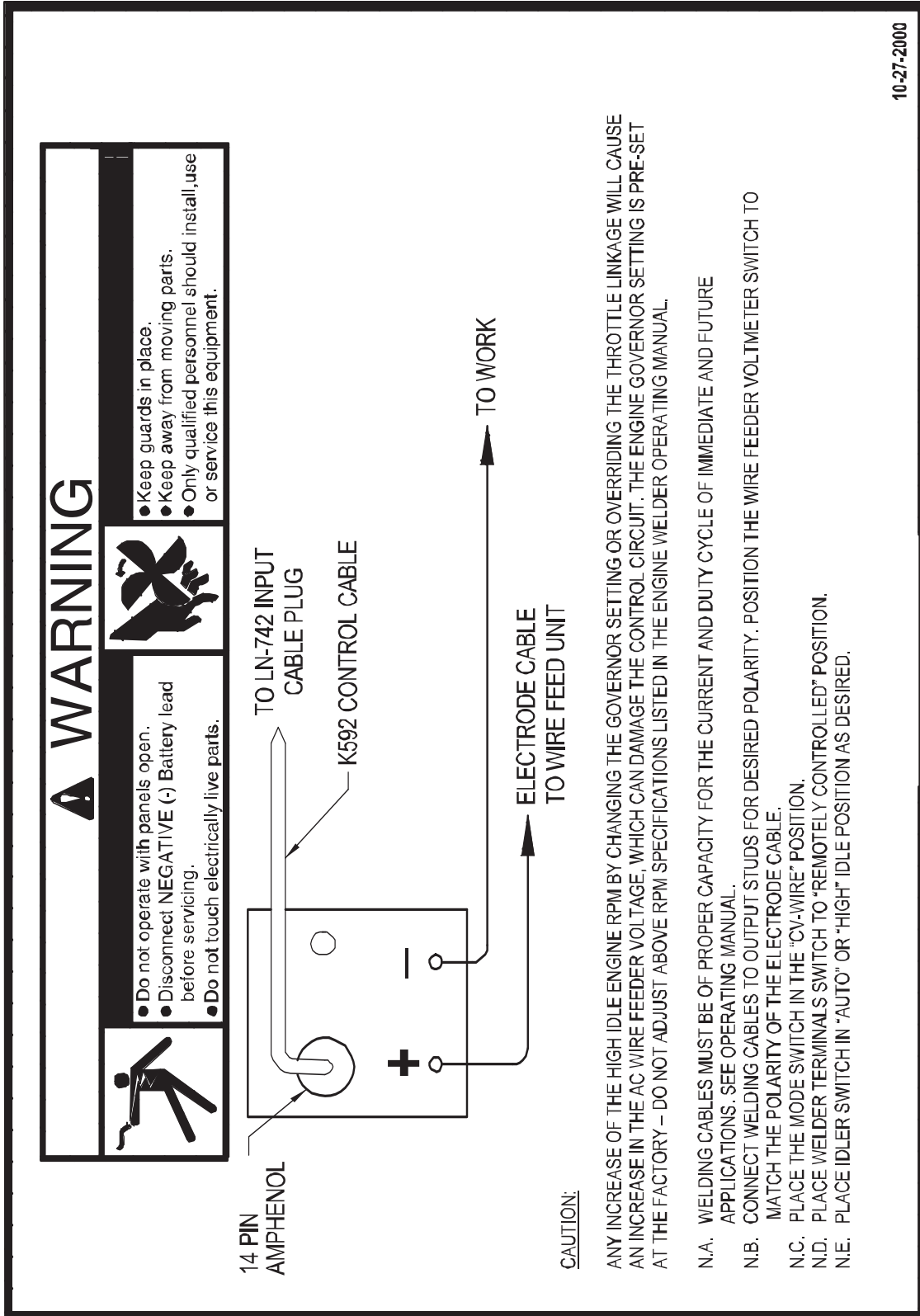

DIMENSION PRINT

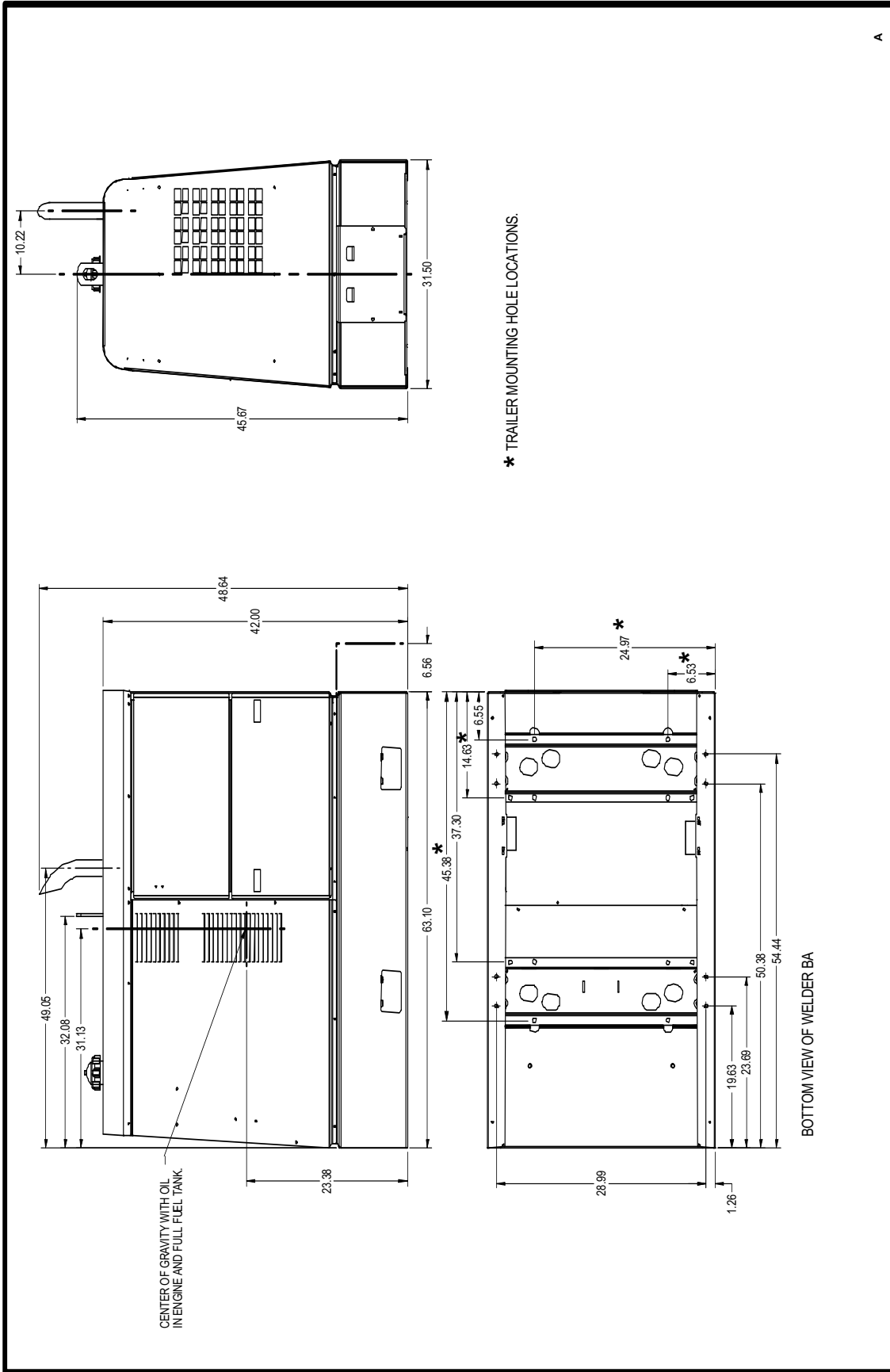

M18962-1

NOTE: This diagram is for reference only. It may not be accurate for all machines covered by this manual. The specific diagram for a particular code is pasted inside the machine on one of the enclosure panels. If the diagram is illegible, write to the Service Department for a replacement. Give the equipment code number.

Vantage 500 DEUTZ



NOTES

VANTAGE 500 DEUTZ



WARNING	<ul style="list-style-type: none"> Do not touch electrically live parts or electrode with skin or wet clothing. Insulate yourself from work and ground. 	<ul style="list-style-type: none"> Keep flammable materials away. 	<ul style="list-style-type: none"> Wear eye, ear and body protection.
Spanish AVISO DE PRECAUCION	<ul style="list-style-type: none"> No toque las partes o los electrodos bajo carga con la piel o ropa mojada. Aislese del trabajo y de la tierra. 	<ul style="list-style-type: none"> Mantenga el material combustible fuera del área de trabajo. 	<ul style="list-style-type: none"> Protéjase los ojos, los oídos y el cuerpo.
French ATTENTION	<ul style="list-style-type: none"> Ne laissez ni la peau ni des vêtements mouillés entrer en contact avec des pièces sous tension. Isolerez-vous du travail et de la terre. 	<ul style="list-style-type: none"> Gardez à l'écart de tout matériel inflammable. 	<ul style="list-style-type: none"> Protégez vos yeux, vos oreilles et votre corps.
German WARNUNG	<ul style="list-style-type: none"> Berühren Sie keine stromführenden Teile oder Elektroden mit Ihrem Körper oder feuchter Kleidung! Isolieren Sie sich von den Elektroden und dem Erdboden! 	<ul style="list-style-type: none"> Entfernen Sie brennbares Material! 	<ul style="list-style-type: none"> Tragen Sie Augen-, Ohren- und Körperschutz!
Portuguese ATENÇÃO	<ul style="list-style-type: none"> Não toque partes elétricas e electrodos com a pele ou roupa molhada. Isole-se da peça e terra. 	<ul style="list-style-type: none"> Mantenha inflamáveis bem guardados. 	<ul style="list-style-type: none"> Use proteção para a vista, ouvido e corpo.
Japanese ● 通電中の電気部品、又は溶材にヒフやぬれた布で触れないこと。 ● 施工物やアースから身体が絶縁されている様にして下さい。	<ul style="list-style-type: none"> 通電中の電気部品、又は溶材にヒフやぬれた布で触れないこと。 施工物やアースから身体が絶縁されている様にして下さい。 	<ul style="list-style-type: none"> 燃えやすいものの側での溶接作業は絶対にしてはなりません。 	<ul style="list-style-type: none"> 目、耳及び身体に保護具をして下さい。
Chinese ● 皮肤或湿衣物切勿接触带电部件及焊条。 ● 使你自已与地面和工件绝缘。	<ul style="list-style-type: none"> 皮肤或湿衣物切勿接触带电部件及焊条。 使你自已与地面和工件绝缘。 	<ul style="list-style-type: none"> 把一切易燃物品移离工作场所。 	<ul style="list-style-type: none"> 佩戴眼、耳及身体劳动保护用具。
Korean ● 전도체나 용접봉을 젖은 헝겍 또는 피부로 절대 접촉치 마십시오. ● 모재와 접지를 접촉치 마십시오.	<ul style="list-style-type: none"> 전도체나 용접봉을 젖은 헝겍 또는 피부로 절대 접촉치 마십시오. 모재와 접지를 접촉치 마십시오. 	<ul style="list-style-type: none"> 인화성 물질을 접근시키지 마십시오. 	<ul style="list-style-type: none"> 눈, 귀와 몸에 보호장구를 착용하십시오.
Arabic ● لا تلمس الاجزاء التي يسري فيها التيار الكهربائي أو الالكترود بجلد الجسم أو بالملابس المبللة بالماء. ● ضم عازلا على جسمك خلال العمل.	<ul style="list-style-type: none"> لا تلمس الاجزاء التي يسري فيها التيار الكهربائي أو الالكترود بجلد الجسم أو بالملابس المبللة بالماء. ضع عازلا على جسمك خلال العمل. 	<ul style="list-style-type: none"> ضع المواد القابلة للاشتعال في مكان بعيد. 	<ul style="list-style-type: none"> ضع أدوات وملابس واقية على عينيك وأذنيك وجسمك.

READ AND UNDERSTAND THE MANUFACTURER'S INSTRUCTION FOR THIS EQUIPMENT AND THE CONSUMABLES TO BE USED AND FOLLOW YOUR EMPLOYER'S SAFETY PRACTICES.

SE RECOMIENDA LEER Y ENTENDER LAS INSTRUCCIONES DEL FABRICANTE PARA EL USO DE ESTE EQUIPO Y LOS CONSUMIBLES QUE VA A UTILIZAR, SIGA LAS MEDIDAS DE SEGURIDAD DE SU SUPERVISOR.

LISEZ ET COMPRENEZ LES INSTRUCTIONS DU FABRICANT EN CE QUI REGARDE CET EQUIPMENT ET LES PRODUITS A ETRE EMPLOYES ET SUIVEZ LES PROCEDURES DE SECURITE DE VOTRE EMPLOYEUR.

LESEN SIE UND BEFOLGEN SIE DIE BETRIEBSANLEITUNG DER ANLAGE UND DEN ELEKTRODENEINSATZ DES HERSTELLERS. DIE UNFALLVERHÜTUNGSVORSCHRIFTEN DES ARBEITGEBERS SIND EBENFALLS ZU BEACHTEN.

Vantage 500 DEUTZ



			
<ul style="list-style-type: none"> ● Keep your head out of fumes. ● Use ventilation or exhaust to remove fumes from breathing zone. 	<ul style="list-style-type: none"> ● Turn power off before servicing. 	<ul style="list-style-type: none"> ● Do not operate with panel open or guards off. 	<p>WARNING</p>
<ul style="list-style-type: none"> ● Los humos fuera de la zona de respiración. ● Mantenga la cabeza fuera de los humos. Utilice ventilación o aspiración para gases. 	<ul style="list-style-type: none"> ● Desconectar el cable de alimentación de poder de la máquina antes de iniciar cualquier servicio. 	<ul style="list-style-type: none"> ● No operar con panel abierto o guardas quitadas. 	<p>Spanish AVISO DE PRECAUCION</p>
<ul style="list-style-type: none"> ● Gardez la tête à l'écart des fumées. ● Utilisez un ventilateur ou un aspirateur pour ôter les fumées des zones de travail. 	<ul style="list-style-type: none"> ● Débranchez le courant avant l'entretien. 	<ul style="list-style-type: none"> ● N'opérez pas avec les panneaux ouverts ou avec les dispositifs de protection enlevés. 	<p>French ATTENTION</p>
<ul style="list-style-type: none"> ● Vermeiden Sie das Einatmen von Schweißrauch! ● Sorgen Sie für gute Be- und Entlüftung des Arbeitsplatzes! 	<ul style="list-style-type: none"> ● Strom vor Wartungsarbeiten abschalten! (Netzstrom völlig öffnen; Maschine anhalten!) 	<ul style="list-style-type: none"> ● Anlage nie ohne Schutzgehäuse oder Innenschutzverkleidung in Betrieb setzen! 	<p>German WARNUNG</p>
<ul style="list-style-type: none"> ● Mantenha seu rosto da fumaça. ● Use ventilação e exaustão para remover fumo da zona respiratória. 	<ul style="list-style-type: none"> ● Não opere com as tampas removidas. ● Desligue a corrente antes de fazer serviço. ● Não toque as partes elétricas nuas. 	<ul style="list-style-type: none"> ● Mantenha-se afastado das partes moventes. ● Não opere com os painéis abertos ou guardas removidas. 	<p>Portuguese ATENÇÃO</p>
<ul style="list-style-type: none"> ● ヒュームから顔を離すようにして下さい。 ● 換気や排煙に十分留意して下さい。 	<ul style="list-style-type: none"> ● メンテナンス・サービスに取りかかる際には、まず電源スイッチを必ず切って下さい。 	<ul style="list-style-type: none"> ● パネルやカバーを取り外した状態で機械操作をしないで下さい。 	<p>Japanese ● 通電中の電気部品、又は溶材にフやぬれた布で触れないこと。 ● 施工物やアースから身体が絶縁されている様にして下さい。</p>
<ul style="list-style-type: none"> ● 頭部遠離須知。 ● 在呼吸區使用通風或排煙設備。 	<ul style="list-style-type: none"> ● 維修前切斷電源。 	<ul style="list-style-type: none"> ● 蓋蓋打開或沒有安全罩時不準作業。 	<p>Chinese ● 皮膚或濕衣物切勿接觸帶電部件綽條。 ● 使你自已與地面和工件絕緣。</p>
<ul style="list-style-type: none"> ● 얼굴로부터 용접가스를 멀리하십시오. ● 호흡지역으로부터 용접가스를 제거하기 위해 가스제거기나 통풍기를 사용하십시오. 	<ul style="list-style-type: none"> ● 보수전에 전원을 차단하십시오. 	<ul style="list-style-type: none"> ● 판넬이 열린 상태로 작동하지 마십시오. 	<p>Korean ● 전도체나 응접봉을 짚은 헝겊, 피부로 절대 접촉치 마십시오. ● 모재와 접지를 접촉치 마십시오</p>
<ul style="list-style-type: none"> ● نود رأسك بعيداً عن الدخان. ● استعمل التهوية أو جهاز تنظف الدخان لتخليصك من أبخرة اللحام التي تنفس فيها. 	<ul style="list-style-type: none"> ● قطع التيار الكهربائي قبل القيام بأية صيانة. 	<ul style="list-style-type: none"> ● لا تلمس هذا الجهاز إلا كانت الأغطية المحيطة الواقية ليست عليه. 	<p>Arabic مس الاجزاء التي يسري فيها التيار برياني أو الالكترود بجلد الجسم أو للايس المبللة بالماء. عاز لا علم، جتمعك خلال العمل.</p>

LEIA E COMPREENDA AS INSTRUÇÕES DO FABRICANTE PARA ESTE EQUIPAMENTO E AS PARTES DE USO, E SIGA AS PRÁTICAS DE SEGURANÇA DO EMPREGADOR.

使う機械や溶材のメーカーの指示書をよく読み、まず理解して下さい。そして貴社の安全規定に従って下さい。

請詳細閱讀並理解製造廠提供的說明以及廠家使用的組件材料，並請遵守貴方的有關勞動保護規定。

이 제품에 동반된 작업지침서를 숙지하시고 귀사의 작업자 안전수칙을 준수하시기 바랍니다.

الرجاء بتمعن وثاقهم تعليمات المصنع المنتج هذه المعدات والمواد قبل استعمالها وتبع تعليمات لتوقاية تصاحب العمل.

Vantage 500 DEUTZ





World's Leader in Welding and Cutting Products

• Sales and Service through Subsidiaries and Distributors Worldwide •

Cleveland, Ohio 44117-1199 USA Tel: 216.481.8100 Fax: 216.486.1751 Web Site: www.lincolnelectric.com